



RADIO'S LIVEST MAGAZINE

Special
Beginner's
Number

Radio-Craft

March
25 Cents
Canada 30c

HUGO GERNSBACK Editor



A "Distance Getter"
— FOR A DOLLAR!
See Page 522

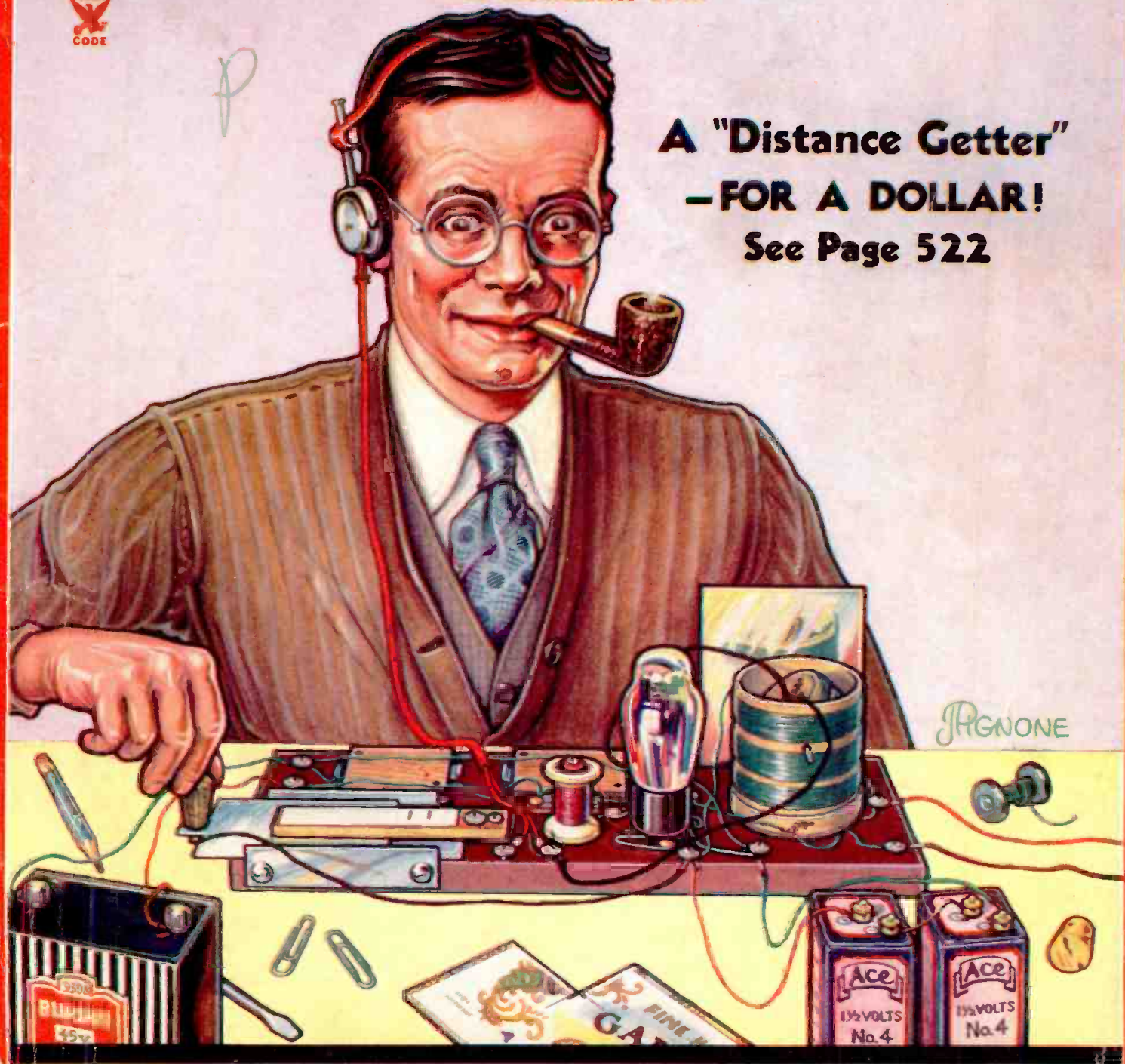

Famous 1-Tube Circuits — Getting Into P. A. Work — "First" Loudspeakers
Putting "Hi-Fidelity" Into Old Sets — Hi-Fidelity, Hi-Gain Amplifier

NEW SENSATIONAL PA.!

36 WATT 10 TUBE AMPLIFIER

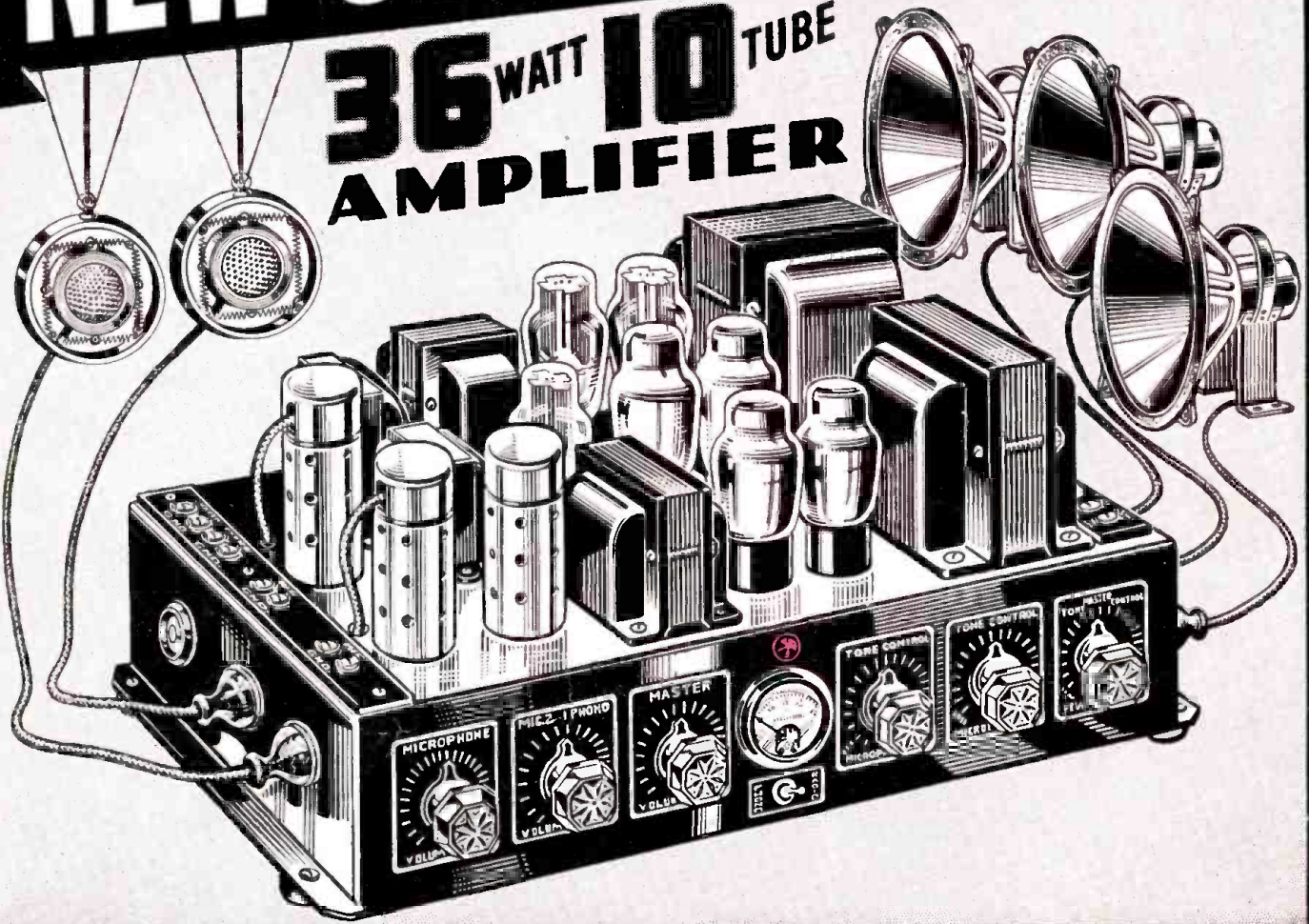

Gain Analysis Stage by Stage

Using as a basis an input signal power of 0.000,000,000,13 watts (about the normal output of a Crystal Microphone). The table below shows the gain in each unit of the amplifier.

Tubes	Mu	Db.
57, (either one)....	100	40
Wunderlich	9	19
53 Triode	25	28
Transformer	4	12
4 P.P. 2B6.....	6½	16

Thus at the maximum usable output of 36 watts the over-all gain is approximately 587,000 Mu (115 Db.).

Tube Specifications

- 2—57 Pentodes
- 1—Wunderlich 2½ V.
- 1—53 as a triode
- 4—2B6 Power Tubes
- 2—5Z3 Rectifiers

Realistic Sound Amplification!

Combined Dual Pre-Amplifier and Power Amplifier

For every type of P.A. Service—For Audiences up to 10,000 persons or Areas up to 30,000 square feet

RADOLEK engineers have accomplished the incredible feat of combining two high gain pre-amplifiers with a 36 watt power amplifier and a single power supply circuit—all in one A.C. operated chassis. Either pre-amplifier may be used alone or both may be mixed in any proportion before reaching the power stage. Individual mike tone controls govern each input. A master tone control adjusts the output to the acoustical conditions within range of the speakers. Individual microphone volume controls mix either input in any proportion. A master volume control adjusts the output volume to suit the audience. Plug-in connections are provided for two crystal microphones and one phono or radio circuit. One, two, or three dynamic speakers may be plugged in sockets provided for them or connected to terminals provided. Amplifier supplies 40 watts field current. Output transformer is tapped for 3, 6, 9, 15, 250, 500, and 1000 ohms, matching all standard speaker voice coils and line circuits.

RADOLEK has combined in this complete, powerful, modern amplifier all the desirable features required in amplification of sound for Public Address service. This new amplifier is strictly all electric—no batteries of any kind are used. Crystal microphones, generating their own current from the sound waves they pick up, deliver to the amplifier crystal clear signals. Two of these rugged modern "mikes" may be used simultaneously with this amplifier. Either one may be "featured" at a higher volume or with a different tone than the other. This is the most desirable feature in orchestra amplification. Also, voice may be blended against Phono or Radio background, etc.

Plug-in connections eliminate installation errors. A "level" indicating meter tells the operator how "loud" he is amplifying the sound at any instant. The power circuit is protected with a standard fuse which will "blow" if the line cord is inserted in any power supply other than 115 volt, 60 cycle A.C.

PRICE LIST

COMPLETE OUTFIT AS ILLUSTRATED, including 250 ft. of 4 wire cable, 100 ft. of 2 wire shielded cable, ten standard tested tubes, 2 Crystal Microphones with ring suspension, and three Oxford Concert type 12½" Speakers. List price **\$250.00**

Amplifier with 10 Matched Tubes, and dummy plugs for speaker sockets, but without Cable, Speakers, or Microphones. Complete instructions for installation and operation included. List Price **\$150.00**

Sold through all Radio Dealers and Radio Servicemen. Standard Dealer Discounts apply.

Features!

- One or two Crystal Mikes
- One or two Ribbon Mikes
- Phono or Radio Input Circuit
- Mixes any Two Inputs
- Individual Input Tone Cont.
- Master Overall Tone Control
- Individual Input Vol. Cont.
- Master Overall Vol. Cont.
- Plug-in and Terminal Connections
- Output Level Indicator
- 40 Watt 400 Volt Field Supply
- 36 Watt "Clean" Output
- Handles 3 to 8 Dynamic Speakers
- Practically Humless Signal
- Very Uniform 40 to 12,000 cycle Audio Range
- Fused A. C. Line Supply
- May be connected in 10 minutes
- Size 21½"x11"x10" high
- Super Service Rubber Cord for connection to 60 cycle 115 Volt A. C.

Send for 24-page Free Crystal Amp. Book. Describes in detail the construction and uses of this amplifier.

Name or Firm.....
 Address.....
 City..... State.....
 Please state intended use of Amplifier.....

Manufactured and Distributed by

THE RADOLEK CO.

584 W. Randolph St.

CHICAGO, ILL.

Dealers and Servicemen: Send for your Free 1935 RADIO PROFIT GUIDE

SAY FELLOWS

I'll FINANCE YOUR TRAINING
IN THE GREAT FIELD OF

RADIO



LEARN BY DOING IN 10 WEEKS

mail the coupon below and I'll give you all the facts about my plan to finance your training - and let you pay for this training in easy monthly payments, which won't start until 60 Days AFTER your 10 weeks training period is over - then you will have over a year to complete your payments.

Then after you have completed your training my employment department will get behind you and give you assistance to help you locate the job for which you have been trained.

Here at COYNE you are trained on actual RADIO-TELEVISION and TALKING PICTURE machinery and equipment, and not by books or lessons - ALL PRACTICAL WORK with only the necessary theory which is given in a practical way. you don't need advanced education or previous experience.

Right now I'm including, at no extra cost, my big new course in ELECTRIC REFRIGERATION AND AIR CONDITIONING.

If you write me today or send coupon I will send you complete details of my sensational new plan and my big Free illustrated book telling all about Coyne and how many EARN WHILE LEARNING.

H.C. Lewis
Pres.

COYNE ELECTRICAL AND RADIO SCHOOL
500 - SOUTH PAULINA ST
CHICAGO ILLINOIS DEPT. 35-8H

MAIL THIS COUPON FOR ALL FACTS

H.C. LEWIS PRES. DEPT. 35-8H
COYNE ELECTRICAL AND RADIO SCHOOL
500 - SOUTH PAULINA ST.
CHICAGO ILLINOIS.

Please send me your big Free book and all the facts.

NAME _____
ADDRESS _____
CITY _____ STATE _____



HUGO GERNSBACK, Editor-in-Chief
 C. W. PALMER Associate Editor
 J. H. RENKENS Associate Editor
 R. D. WASHBURNE, Technical Editor



FEATURING ELECTRONICS IN OUR NEXT ISSUE

CONTENTS OF THE MARCH, 1935, ISSUE

Volume VI

Number 9

Editorial: The Modern Radio Beginner.....	517
The Radio Month in Review.....	518
Beginner's Radio Pictorial.....	520
A "Distance Getter" for a Dollar!.....	522
The Earliest Loudspeakers.....	523
The Modern Theory of Electricity (Part I).....	524
Replacement Status of the New Tubes.....	
..... H. M. Neustadt	525
How to Read Radio Diagrams..... R. D. Washburne	526
Famous I-Tube Circuits.....	528
International Radio Review.....	529
Radio De-Bunked..... C. W. Palmer	530
Short-Cuts in Radio.....	532
Build This 5-Tube, All-Wave Superhet All-Star "Junior".....	534
A Simple "I-Tube" All-Wave, All-Electric Set.....	
..... W. Green	536
Putting "Hi-Fidelity" Into Old Sets.....	
..... Wilhelm E. Schrage	537
Latest in Radio.....	538
Operating Notes.....	540
How to Get Started in P.A. Work.....	
..... C. R. Shaw and H. Seymann	541
How to Make a Sensitive, Inertia-Type Relay for Radio Dynamics.....	
..... F. D. Andrews	542
The Man-Back P.A. System.....	
..... J. M. Kuhlik and Paul Komroff	543
Adding a "Tweeter" for High-Fidelity.....	543
A Simple All-Wave Oscillator..... E. M. Shiepe	544
A "3-in-2" Short-Wave Set..... A. G. Heller	544
How Resistors Are Made..... Ralph Sayres	545
A Pre-Amplifier for the Short-Wave Receiver.....	
..... H. B. Russ	545
A Versatile, 10-Tube, 36-Watt, P.A. Amplifier.....	
..... J. P. Kennedy	546
ORSMA Members' Forum.....	547
RADIO-CRAFT'S Information Bureau.....	548
RADIO SERVICE DATA SHEETS:	
No. 133—Clarion No. TC-31 5-Tube A.C.-D.C. Superhet.; —Erla Model 4500 Dual-Wave T.R.F. 4-Tube A.C. Receiver.....	550
No. 134—Stewart-Warner Models 1271 to 1279 All-Wave Supers.; —Colonial Model 652 5-Tube Broadcast—Short-Wave Superhet.....	551
Book Reviews.....	576

The term "electronics" refers not only to the vacuum tube as used in radio receivers, but also to other devices that operate as the result of electron motion, wherever found, and next month RADIO-CRAFT is going to feature "electronics."

Articles by leading authorities will contain valuable information on the latest applications of the vacuum tube. Interesting practical uses for the photoelectric cell will be portrayed and explained. There will be an informative story on the construction of an A.C.-operated vacuum-tube voltmeter. All of the usual RADIO-CRAFT departments will contain their quota of profitable and interesting information for the wideawake Service Man and experimenter.

It is going to be a bang-up issue, one you will not care to miss. We hope that beginners and old-timers alike will read it from cover to cover and be helped by so doing.

RADIO-CRAFT is published monthly, on the fifth of the month preceding that of date; its subscription price is \$2.50 per year. (In Canada and foreign countries, \$3.00 a year to cover additional postage.) Entered at the post office at Mt. Morris, Ill., as second-class matter under the act of March 3, 1879.

Text and illustrations of this magazine are copyright and must not be reproduced without permission of the copyright owners. We are also agents for WONDER STORIES and EVERYDAY SCIENCE AND MECHANICS. Subscription to these magazines may be taken in combination with RADIO-CRAFT at reduced Club rates. Write for information.

Copyright 1935. Continental Publications, Inc.

HUGO GERNSBACK, President I. S. MANHEIMER, Secretary

Published by Continental Publications, Inc. Publication office: 404 N. Wesley Ave., Mount Morris, Illinois. Editorial and Advertising Office: 99 Hudson Street, New York City. Chicago Advertising Office: L. F. McClure, 919 North Michigan Avenue, Chicago, Ill. Western Advertising Office: Loyd B. Chappell, 511 So. Alexandria St., Los Angeles, Calif.

London Agent:

Hachette & Cie., 3 La Belle Sauvage, Ludgate Hill, E.C. 4

Paris Agent: Hachette & Cie., Australian Agent: McGills Agency

111 Rue Reamur

179 Elizabeth St., Melbourne



J. E. Smith, President National Radio Institute

I WILL HELP YOU START A SPARE TIME OR FULL TIME RADIO SERVICE BUSINESS WITHOUT CAPITAL

HERE ARE A FEW EXAMPLES OF THE KIND OF MONEY I TRAIN MY MEN TO MAKE

Clears \$4500 in 18 Months

"Before taking your Radio Course I was making \$18 a week. I came here three years ago. In about 18 months I made about \$4500 in Radio. I cannot say too much for the wonderful help I have received from N. R. I."
Noel W. Ray,
619 Broad St.,
Gadsden, Alabama.



Spare Time Work Pays \$18 a Week

"I only do spare time Radio work and average \$18 a week. People who in good times would buy a new radio, now have the old one fixed."
Stephen J. Drapehuty,
407 Wunderlich Avenue,
Barberton, Ohio.



Now Owns Own Business

"If I had not taken your Course I would be digging ditches instead of running my own business. One week I made \$75 on repairing alone, and this doesn't count sales. If a fellow wants to get into Radio, N. R. I. is the starting point."
R. S. Lewis,
Modern Radio Service,
Pittsfield, Ill.



You Get PRACTICAL EXPERIENCE with Radio Equipment I Give You

My Course is not all theory. I'll show you how to use my special Radio equipment for conducting experiments and building circuits which illustrate important principles used in such well-known sets as Westinghouse, General Electric, Philco, R.C.A., Victor, Majestic, and others. You work out with your own hands many of the things you read in our lesson book. This 50-50 method of training makes learning at home easy, interesting, fascinating, intensely practical. You learn how sets work, why they work, how to make them work.

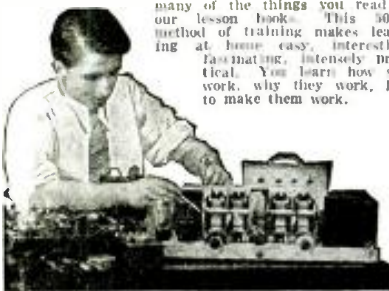

Free Book Tells How Mail Coupon!

The world-wide use of Radio sets for home entertainment has made many opportunities for you to have a spare time or full time Radio business of your own. I give you instructions early in your Training for doing 28 Radio jobs common in almost every neighborhood. Many N. R. I. men make \$5, \$10, \$15 a week extra in spare time while learning. I show you how to install and service all types of receiving sets. I give you Radio equipment and instructions for conducting experiments, for building circuits and testing equipment, and for making tests that will give you broad, practical Radio experience. Clip the coupon below and get my free 64-page book, "Rich Rewards in Radio"—it gives you a full story of the success of N. R. I. students and graduates, and tells how to start a spare time or full time Radio business on money made in spare time while learning.

Many N. R. I. Men Make \$5, \$10, \$15 a Week Extra in Spare Time While Learning

Many of the seventeen million sets now in use are less than 50% efficient. I will show you how to cash in on this condition. I will show you the plans and ideas that have enabled many others to make \$5, \$10, \$15 a week in spare time while learning. Ford R. Leary, 1633 Davison Road, Flint, Mich., wrote: "My part-time earnings while taking the N. R. I. Course were \$651."

Get Ready Now for a Radio Business of Your Own and for Jobs Like These

Broadcasting stations use engineers, operators, station managers, and pay up to \$5,000 a year. Radio manufacturers use testers, inspectors, foremen, engineers, servicemen and buyers, and pay up to \$6,000 a year. Radio dealers and jobbers employ hundreds of servicemen, salesmen,

managers, and pay up to \$5,000 a year. Radio operators on ships enjoy life, see the world, with board and lodging free, and get good pay besides. My book tells you of the opportunities in these fields, also in Aviation Radio, Television, Police Radio, Short Wave Radio, Automobile Radio and other new branches of this fast growing industry. Get it.

I Train You at Home in Your Spare Time

Hold your job until you're ready for another. Give me only part of your spare time. You do not need a high school or college education. Hundreds with only a common school education have won bigger pay through N. R. I. J. A. Vaughn jumped from \$35 to \$100 a week. J. E. McLaurine increased his earnings 100 per cent. The National Radio Institute is the Pioneer and World's Largest organization devoted exclusively to training men and young men by Home Study for good jobs in the Radio industry.

You Must Be Satisfied

I will give you an agreement to refund every penny of your money if you are not satisfied with my Lesson and Instruction Service when you complete my Training. And I'll not only give you thorough training in Radio principles, practical experience in building and servicing sets, but also Advanced Specialized Training in the type of Radio work you choose.

Get My Free Book of Facts

Mail the coupon for "Rich Rewards in Radio." It's free to any ambitious fellow over 15 years old. It tells you about Radio's spare time and full time opportunities; about my training; what others who have taken it are doing and making. Mail coupon now in an envelope, or paste it on a 1c post card.

J. E. SMITH, Pres.
Dept. 5CX
National Radio Institute
Washington, D. C.



FREE: Radio Servicing Tips

Let me PROVE that my Course is clear, easy to understand and fascinating to study. Send the coupon for a free lesson, "Trouble Shooting in D.C., A.C., and Battery Sets." This interesting lesson gives 132 ways to correct common Radio troubles. I am willing to send this book to prove that you too can master Radio—



just as thousands of other fellows have done. Many of them, without even a grammar school education and so Radio or technical experience, have become Radio experts and now earn two or three times their former pay. Mail coupon now.

This Coupon is Good For One FREE COPY OF MY NEW BOOK

J. E. SMITH, President,
National Radio Institute,
Dept. 5CX,
Washington, D. C.



Dear Mr. Smith: Without obligation, send me the Service Manual and your free book about spare time and full time Radio opportunities, and how I can train for them at home in spare time. (Please print plainly.)

Name..... Age.....

Address

City..... State..... "M"

Find out about the World Famous Course that Pays for Itself

Please Say That You Saw It in RADIO-CRAFT

Radio Men!

**GOOD BOOKS WHICH HELP
MAKE RADIO WORK MORE PROFITABLE**

Presented on this page are books of the RADIO-CRAFT LIBRARY SERIES—a most complete and authentic set of volumes treating individually, important divisions of radio. Each book has been designed to give radio men the opportunity to specialize in one or more of the popular branches of the industry. You will find them a real help in your work and they will contribute to your money earning capacity. Read these books during your spare time at home.

The authors of these books are well-known to everyone. Each is an expert radio man; an authority on the subject—each is thoroughly familiar with the field which he represents.

This is the first real opportunity that you have ever had to build a library of radio books that are authentic. MOST OF THE BOOKS HAVE BEEN RECENTLY REVISED AND REWRITTEN TO KEEP THEM UP TO THE MINUTE. Mail coupon below for your books.

Book No. 1
Radio Set Analyzers
And How To Use Them
By L. VAN DER MEL
With Full Instructions and Descriptions of Set Analyzers, Tube Checkers, Oscillators, etc. (Just revised.)

Book No. 2
Modern Vacuum Tubes
And How They Work
By ROBERT HERTZBERG
With complete Technical Data on All Standard and Many Special Tubes. (Just revised.)

Book No. 3
The Superheterodyne Book
All About Superheterodynes
By CLYDE FITCH
How They Work, How to Build and How to Service Them.

Book No. 4
Modern Radio Hook-Ups
The Best Radio Circuits
By R. D. WASHBURN
A Complete Compendium of the Most Important Experimental and Custom-built Receivers.

Book No. 5
How to Become a Radio Service Man
By LOUIS MARTIN
How to get started in the business of servicing radios and how to make money in this field.

Book No. 6
Bringing Electric Sets Up to Date
By CLIFFORD E. DENTON
With Pentodes, Multi-Mus, Dynamic Speakers—Complete Information How to Modernize A. C., D. C. and Battery Operated Receivers.

Book No. 7
Radio Kinks and Wrinkles
By C. W. PALMER
For Service Men and Experimenters
A Complete Compendium on the Latest Radio Short-Cuts and Money Savers—These Kinks Are Great Time-Savers.

Book No. 8
Radio Questions and Answers
By R. D. WASHBURN
A Selection of the Most Important of 5,000 Questions Submitted by Radio Men During the Course of One Year—They Are All Answered by a Technical Expert.

Book No. 9
Automobile Radio and Servicing
By LOUIS MARTIN
A Complete Treatise on the Subject Covering All Phases from Installing to Servicing and Maintenance. A Book That Is Greatly Needed Today. (Just Revised.)

Book No. 10
Home Recording and All About It
By GEORGE J. SALIBA
A Complete Treatise on Instantaneous Recordings, Microphones, Recorders, Amplifiers, Commercial Machines, Servicing, etc.

Book No. 11
Point-to-Point Resistance Measurements
By CLIFFORD E. DENTON
The Modern Method of Servicing Radio Receivers—a Book Which Radio Service Men Have Referred to More Than Any Other.

Book No. 12
Public Address Installation and Service
By J. T. BERNSELY
Modern Methods of Servicing and Installing Public Address Equipment.

Big Discount To You

In order to make it possible for everyone to buy these books, the fifty (50) cent price has been made uniform for all volumes. You can buy these books separately, but you should take advantage of our special offer:

When Five (5) Books Or More Are Ordered Deduct 20% From Your Remittance

Simply fill in the coupon at left, and mail it to us together with your remittance, checks, stamps or money orders accepted.

- Here are the subjects covered--**
- Set Analyzers
 - Tubes
 - Superheterodyne Circuits
 - Radio Hook-ups
 - Servicing Business
 - Modernizing Electric Sets
 - Kinks and Wrinkles
 - Questions and Answers
 - Auto-Radio Servicing
 - Home Recording
 - Resistance Measurements
 - Public Address

All Books Uniform Volumes are all uniform size, 6 x 9 inches, and contain on an average of 50 to 120 illustrations. Each book is printed on fine paper and no expense has been spared to make it an outstanding value.



CLIP-MAIL THIS COUPON TODAY!

GERNSBACK PUBLICATIONS, INC., 99 Hudson Street, New York, N. Y.

I have circled below the numbers of books in the RADIO-CRAFT LIBRARY SERIES which you are to send me, and have deducted 20% for ordering five (5) books or more. I have included my remittance in full, at the price of 50c each, when less than five books are ordered.

The amount of my remittance is..... (Stamps, checks or money orders accepted.)

Circle numbers wanted: 1 2 3 4 5 6 7 8 9 10 11 12

Name Address

City State RC-335

Please Say That You Saw It in RADIO-CRAFT



"Takes the Resistance out of Radio"

MODERN RADIO BEGINNERS

An Editorial by HUGO GERNSBACK

THE radio beginner has been with us for over twenty-five years, during which time he has gone through various stages of evolution.

In the early years, when radio was called "wireless," the radio beginner was then an amateur with a spark coil and a coherer set trying to catch the elusive dots and dashes. He in turn graduated into a radio experimenter, a successor to the radio beginner, and started to play with crystal detectors, tuning coils, and simple radio sets, in order to catch the first radio broadcast which made its appearance about 1920. Still later, a new crop of beginners came on the scene with the advent of the vacuum tube, regeneration, and all that went with it. One, two, three, and up to ten tube sets were built by these beginners and radio became more and more complex. The later beginner had to know more than those who preceded him because the art in the meanwhile had become more complex. New circuits were evolved—the regenerative circuit, tuned radio frequency, superheterodyne, super-regeneration, and many subdivisions of these fundamental circuits. New and better tubes were placed upon the market and the simple four-prong three-element tube gradually evolved into the complicated tubes of today with six and seven prongs and grid caps, yet the end is not in sight.

In the meanwhile, the lure to the radio beginner is unabated. There are as many radio experimenter-beginners today as ever before. I have frequently stated that there are between 250,000 and 300,000 radio beginners and experimenters in this country, and it now looks as if this estimate might be increased considerably during the next few years.

In the first place, an entirely,—and I may say,—a totally new crop of beginners has come to life during the past two or three years in the short-wave field alone. These radio beginners are of a similar type to those existing in 1920 to 1925 and these newcomers are finding out for themselves the thrill of distance, which those beginners of 1923 never experienced. In those days, 500 miles or 800 miles was a fine record to shoot for. Today, the short-wave beginner thinks nothing of receiving speech and music from a station 12,000 miles distant. This is, as a matter of fact, an everyday occurrence.

But we do not stop here as far as the radio beginner is concerned because after all, radio receiving and transmitting sets do not constitute all of radio today. The art is much more complex than that. There is, for instance, the radio Service Man, who does not fall from the heavens as a fully matured Service Man. He too, has to be a beginner at some time. He usually starts with a small home-made measuring instrument and he may not be at all interested in building a radio set, either for receiving or transmitting. He finds the sets as they are. He teaches himself or is taught how to service such sets from

an electrical measuring and testing viewpoint. By means of his meters and instruction book he soon finds out the fundamentals of a radio set without ever having built one himself. He is in the same class as an expert automobile repairman who has been taught the intricacies of an automobile without ever having built or assembled one himself. There are now close to 20 million radio sets in this country that require servicing. There are graduating every year, thousands of radio Service Men, who start as raw beginners, with nothing more than a meter and a pair of test clips, and soon become expert in testing circuits.

Then we have the beginner in the public address field. This man too, is not interested in building radio sets but is more interested in playing with sound equipment, all of which is radio in another guise. He may build his first two-stage amplifier or again he may not. All he will be interested in is knowing what the circuits of the amplifiers are and what it is all about, and from little beginnings he soon masters the intricacies of the amplifier art and either becomes a public address expert or installs public address systems. To do so, he need not be an expert on radio sets, and indeed, he need never have built such sets himself, although we know from experience that better than 90 per cent of amplifier, public address, and Service Men, too, for that matter, sooner or later will succumb to the lure of building a radio set just for the fun of it, and the minute they do so they, of course, become beginners in this field also.

Then, we have still another type of modern radio beginner who is interested only in electronics, that branch of radio which is growing by leaps and bounds, and which embraces many classes, from the photoelectric field to distant or remote control.

The photoelectric radio art is particularly alluring to the beginner because he can perform many spectacular stunts with his photoelectric cell and his amplifier. New uses are springing up every day and new applications are found for photoelectric cells almost daily. Nowadays, the electronics beginner performs such stunts as opening the garage door from a distance by means of the car's headlights, opening doors the instant a person passes a light-beam, turning on an electric lighting system by extending his hand in the path of a pilot lightbeam, talking over a lightbeam with friends at a distance, etc.

And best of all, the modern radio beginner, no matter in what branch of radio he starts, will soon graduate into a class where his former experience can be translated into dollars and cents. It is a fact, that by far the larger percentage of radio beginners sooner or later cash in on their experience and talents. Knowledge thus gained is never lost. **Every Marconi, every de Forest was once a radio beginner—never forget that.**

THE RADIO MONTH



© M. Roschfeld.

The late Dr. Watson with a replica of the first telephone.

DR. WATSON— MAKER OF FIRST TELEPHONE—DIES

—LAST month marked another mile stone in the history of telephony and radio, when Dr. Thomas A. Watson, a close companion of Alexander Graham Bell, and maker of Bell's first microphone, died of heart disease.

Dr. Watson and Professor Bell became acquainted during the latter's early experiments. On the afternoon of June 2, 1875, the two men were working on Bell's "harmonic telegraph" when one of the transmitter strings stopped vibrating and Watson plucked it again, the plucking sound being carried over the wires to Bell, who then recognized the beginning of the telephone.

"After having made the first telephone and put up the first telephone wire," Dr. Watson said in an interview, recently, "I also had the distinction of hearing the first words ['Mr. Watson, come here; I want you!'] ever spoken over the telephone."

He retired in 1903 from active business but always retained his interest in telephony and in 1920 envisioned trans-Atlantic conversations as only the beginning of development in this method of communication.

The importance of the telephone transmitter to the development of radio, especially radio broadcasting, can readily be appreciated by any radio technician.

RADIO "FINDS" LOST FLIERS— AND HELPS IN RESCUE

—WHEN a giant Boston-Cleveland air liner, towards the end of last month, missed its course and crashed on a wooded mountainside some distance north of Utica, New York, radio played an important part in finding the four men aboard the ship.

The pilot of the wrecked plane, Ernest Dryer, reported the condition of the plane and what he considered to be the approximate location. This contact to the dispatch radio station in Albany started an immediate search and is probably responsible for finding the injured men before the sub-zero temperatures and exposure had caused a fatality.

As soon as the distress call had been received, radio stations in the United States and Canada sent signals from four different directions to aid the pilot to find his exact location by "triangulation." The use of these beam signals is a distinct novelty and perhaps the only case on record where radio *beacons* were used to locate a distressed "ship" on land.

Finally, radio played an important part in directing the squadron of rescue planes.

It is interesting to note that a heated discussion, as to whether the radio beam on which Dryer was supposed to be flying, was turned off immediately before the accident. Department of Commerce officials at the Albany airport finally decided that the beam was on all that night.

Radio beam stations aided the marooned fliers to find their exact location.

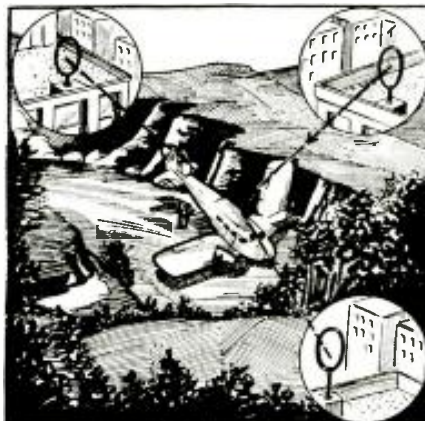

THEORIES OF SOUND—UPSET

—THE coming of the new year also brings news to science. Each year the American Association for the Advancement of Science gives a prize of \$1000 for "a noteworthy paper" and this year the award goes to Prof. Vern O. Knudsen of the U. of Calif.

The prize winning paper describes what are regarded as "epoch-making investigations" in the fundamental principles of the propagation of sound.

According to Prof. Knudsen, there is reason to suppose that as sound travels through air, collisions are brought about between molecules. The oxygen molecules become very excited while those of nitrogen are more stable. The warbling of a bird, scarcely audible in oxygen at fifty yards, is a delight to the ear in nitrogen. Apparently new molecules of hydrogen peroxide are formed in our complex air—which as you know is composed largely of nitrogen and oxygen.

Peroxide? The word ties in so suspiciously with blond hair that one imaginative commentator suggests in a New York paper that jazz played in the proper atmosphere may yet change milady's dark tresses to flaxen.

RADIO WAVES VARY IN SPEED

—UNTIL recently, scientists have assumed that radio waves travel at the speed of light—that is, about 186,000 miles per second. Not long ago, the startling news was heard that this speed is not constant.

Last month, at the beginning of the new year, an eminent authority—Dr. Harlan T. Stetson—offered proof that this is the case, and explains why.

Dr. Stetson says that this may be accounted for by studies which "indicate that the nearer the propagation path (of the radio waves) lies to the earth's magnetic pole, the greater is the retardation of the velocity of the wave. Since the velocity of the electromagnetic wave depends on the density of the medium, it is believed that conditions in the ionosphere are seriously modified by the electromagnetic field of the earth."

He found that signals from Rugby to Annapolis vary greatly in speed, while those from Bordeaux do not vary.

IN REVIEW

Radio is now such a vast and diversified art it becomes necessary to make a general survey of important monthly developments. RADIO-CRAFT analyzes these developments and presents a review of those items which interest all.

SHIPS IN DISTRESS CALL FOR HELP BY RADIO

RADIO, which has served so many times in recent years to aid the passengers and crews of disabled and sinking ships, worked overtime last month, when the storm-swept seas caused three ships to founder and many more to call for immediate help.

The steamer Sisto sent out an SOS when she lost her rudder and propeller—the liner New York rescued the 16 men of the crew after battling many hours with the raging seas.

The Oakmor, also in the Atlantic, reported her engines disabled and drifting helplessly. (She was able to proceed, however, when temporary repairs were made.)

The British steamer Ortegale, in the Pacific, about 400 miles out of Port Townsend, Wash., reported that her deck load had shifted in the heavy roll and she was in immediate danger of capsizing.

When a volunteer crew from the steamer Jean Jadot attempted to take off some of the men on the disabled freighter Usworth, the life-boat capsized and 8 men, 2 of whom were members of the rescue crew, were lost in the violent sea.

At about the same time, officials at Marseilles reported that hope had been abandoned for the Schiaffino XXIV, which was lost in the Mediterranean.

In addition to these tragedies, the Mackay radio service reported that two SOS calls, blurred by atmospheric disturbances were received, but their source was not determined.

Freighter Usworth sinking—view from deck of Ascania. Radio saved 30 of crew.



© Acme.

RADIO CONCERNS TO MERGE

WITH the tacit approval of President Roosevelt, the Federal Communications Commission came to a definite decision, last month, and before Feb. 1, will recommend to Congress that legislation be enacted to permit a gigantic merger in communications—despite anti-trust laws.

Eligible under this merger are the following: The International Telephone and Telegraph Corp., including Postal Telegraph Co.; R.C.A. Communications, Inc., and Western Union.

At about the same time, it was reported that the RCA Victor Co. and RCA Radiotron Co. would be consolidated and be known as RCA Manufacturing Co., Inc.

BYRD LEAVES LITTLE AMERICA

A RADIOGRAM received from Little America, at the middle of last month stated that the Byrd Antarctic Expedition intended to leave for New Zealand and New York at about the end of January.

The Little America radio station reported that the explorers would stop at Dunedin, New Zealand, about the middle of February. Admiral Richard Byrd said he hoped to reach New York early in the spring.

Thus the interesting programs originating in the Antarctic wastes are ended.

Admiral Byrd with his whole band of explorers is returning to civilization.



The 10 million volt discharge which identifies station W2XAF's broadcasts.

A "CALL" OF 10 MILLION VOLTS FOR W2XAF!

STATION identifications have taken some weird forms, from bird calls to national anthems, but perhaps the most unusual is the new signature of station W2XAF—the short-wave companion of WGY—in Schenectady, N.Y.

The "call" which started at the end of last month, is that of 10,000,000 volts of artificial lightning and it sings three crashing bars at the beginning and end of every short-wave broadcast signifying that Schenectady, where the late Charles P. Steinmetz competed with nature by manufacturing his own thunderbolts, is on the air.

NEW RADIO LANGUAGE BASED ON MUSIC

MUSIC has often been called the "international language" as it is understood by people of all tongues—and it is on the basis of the musical scale that Carlo Spartari bases his new "radio language."

This new means of communicating with people who speak different languages provides 960,799 different words made out of the seven notes of the scale, as compared to half that number in the English language—according to the originator. Each word

(Continued on page 562)

RADIO PICTORIAL

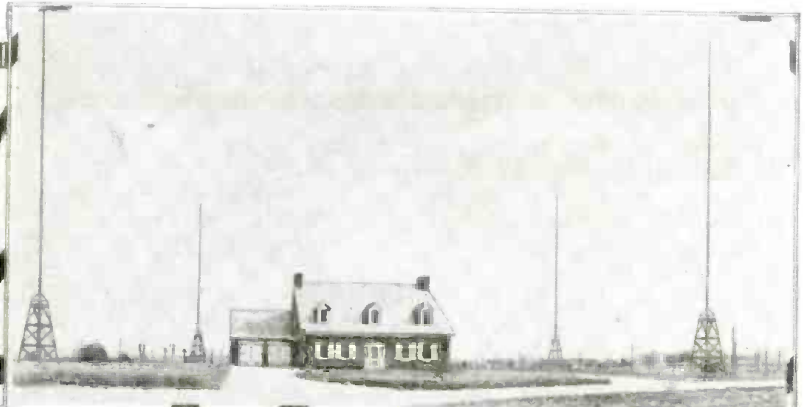
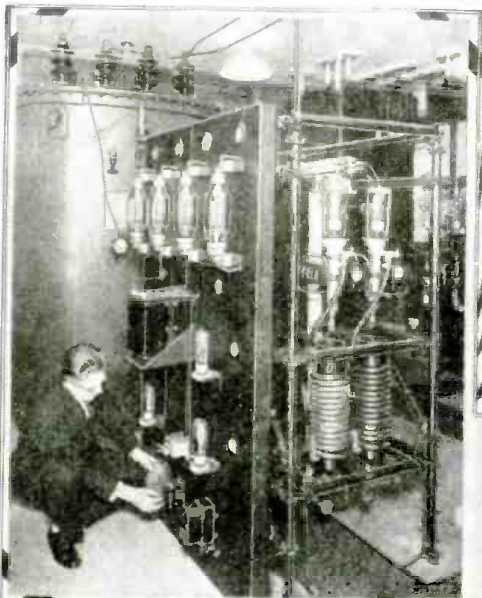

Views of "new" broadcasting station KYW, Philadelphia. Left, speech amplifier. Above, general view. Below, counterpoise and rod antenna. Right, control room.

(Photos: Westinghouse Elec. & Mfg. Co.)

VERTICAL-ROD ANTENNA (1 OF 4)

TUNING HOUSE

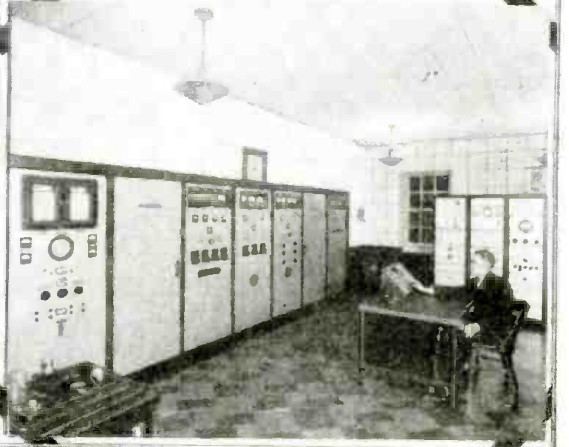

KYW Features
 Carrier Power—50 kw.; Modulation Capacity—100%; Frequency—990 kc.; Power Supply—4,150 V., 3-phase, 60 cycles; Power Input—277 kw. (including lights). R. F. Output Tubes—8-207; Modulator Output tubes—4-848; Class of Modulation—high level, class B; Modulation Fidelity—+2 db., 30 to 8,000 cycles. Main Rectifier tubes—6-857; Main Rectifier Output—12,000 V., 17 Amps., D.C.; Frequency Source—quartz crystal osc.; Frequency Stability—.005%, or better; Tube Cooling—closed circuit of distilled water; Tube Filament Supply—all A.C. (no generators). P. A. Tank Condensers—nitrogen pressure filled; Harmonic Reduction—uses static shield and balance tank condensers; Method of Clearing Carrier Noise—magnetron

suppressor. Monitoring Devices: (1) cathode ray oscilloscope; (2) frequency; (3) over-modulation indicator; (4) high-quality reproducer; (5) rectox volume indicators; (6) misc. automatic monitors. Recently KYW moved from its old home in Chicago, taking with it some completely new ideas in broadcasting equipment. Representing in the fullest measure the ripening years of radio engineering development, station KYW, whose call letters have been familiar to the broadcasting world since 1921, goes into operation at Philadelphia. Completely new facilities have been provided for the station including not only directional antennae, but also innovations in the design, and location of the various elements comprising the new transmitter. A few features are: four vertical rod antennae, phased to direct the transmission into Philadelphia and Allentown, avoiding interference with other stations in its channel; nitrogen-filled condensers in the tank circuit, saving a large amount of space; cathode-ray oscillograph check on modulation; entire absence of rotating machinery; one-man operation; duplicate, interchangeable frequency-control crystals; and magnetron suppressor. The high-quality amplification employed in the new station results in exceptionally faithful transmission of all input frequencies from 30 to 8,000 cycles. Philadelphia is fortunate indeed to secure the services of this highly original, super-directional, sterling quality station, RADIO-CRAFT'S Listening Post will welcome any and all reports of reception of KYW's transmission quality and distance covered.



The above is a 3-tube "bathroom radio" in the home of Hugo Gernsback, editor of RADIO-CRAFT (see his editorial in the October 1934 issue "Radio in the Bathroom"). Waterproofed entirely, neither steam nor water can penetrate its interior. It hangs on the wall. The casing matches the bathroom color scheme.



Above, in center, is shown one of the guest room radio installations at the Hotel Lexington, New York City. Since the hotel installed this equipment in its 801 guest rooms and 10 private dining rooms, many comments have been received regarding the quality of reception. This quality is due largely to the master receiver set-up. Each of four separate high-fidelity receivers is tuned to a high-class broadcasting station. Since each receiver has its own antenna system, and class A amplification is used throughout, the results are extremely good.

At right is a novel device in the home of Hugo Gernsback, editor of RADIO-CRAFT. It consists of a clock-switch, A which automatically turns the radio B on and off at pre-determined times. It wakes him up in the morning, too.





Left, a "tissue-phon," enabling the deaf to plainly hear speech and music. Also it is claimed to have a beneficial and, in some cases, restorative effect upon hearing. A vibrating element connects by a coiled spring (wound "on air") to radio reproducer. The vibrations act upon tissues and bones of the ear.

Right, a "magic-wand" which controls the volume of a radio set or shuts it off completely. It makes use of pressure of the fingers (varying resistance between aerial and ground) and an inconspicuous switch



(Press Photo)

Left, the London School of Broadcasting has been founded to help new talent on the air get over what is known as "microphone fright." Each audition is recorded on phonograph records. After the audition the future star can hear exactly how his, or her, rendition would sound to a broadcast listener. Girl is listening to her own voice.

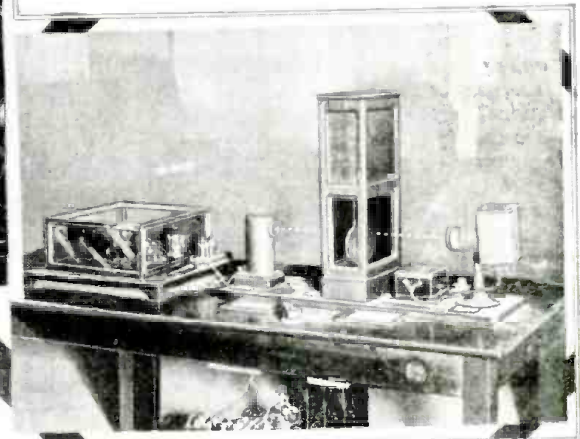

A demonstration model of a photoelectric cell in action. The pendulum of a clock-movement interrupts the light supplied to the cell. Each interruption causes the cell to operate a relay, which in turn actuates a mechanical recorder. This simple device demonstrates the operation of all photoelectric cells.

(Courtesy, The New York Museum of Science and Industry.)

At right, an exhibition model of a "B" eliminator. Using a 2-element tube as rectifier and an audio-transformer for step-up voltage, it supplies unfiltered D.C. for plate circuits. Below is a model of similar construction designed to illustrate the "Edison effect" or electronic emission. A milliammeter shows current flow between filament and plate.

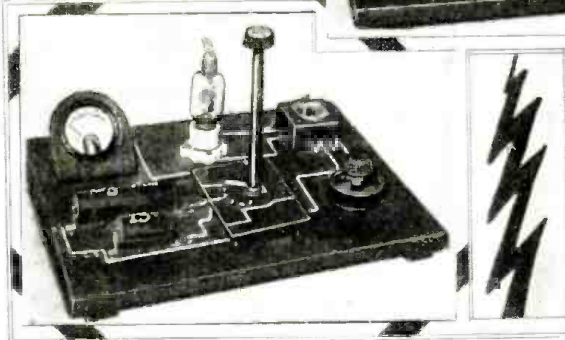
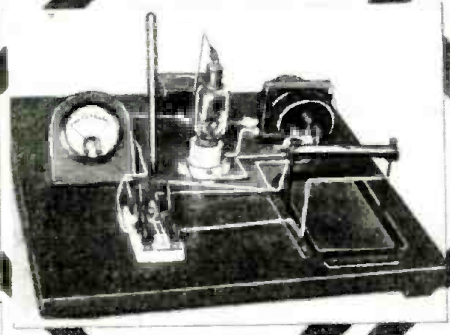

A very instructive and interesting exhibit representing the history of the microphone recently was on display at Radio City, New York (right). The large parabolic reflector types were used, with small telescopes, as "spot" microphones to pick up operatic voices from the stage. The fourth from left is a type used to conceal the mike and therefore reduce microphone fright! Fifth from left is the studio type universally used for years in broadcast work; the velocity type, extreme right, is now preferred. Each of the other models has its own history and at one time or another occupied its "place in the sun."

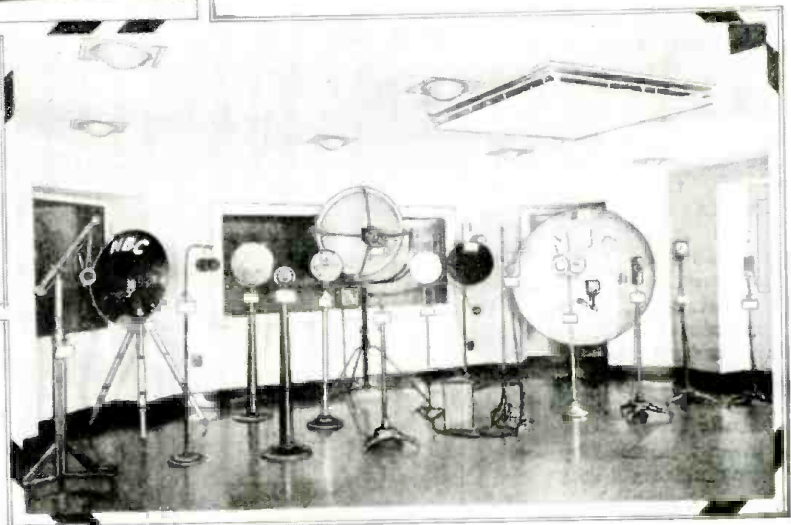

A "DISTANCE-GETTER"—FOR A \$1

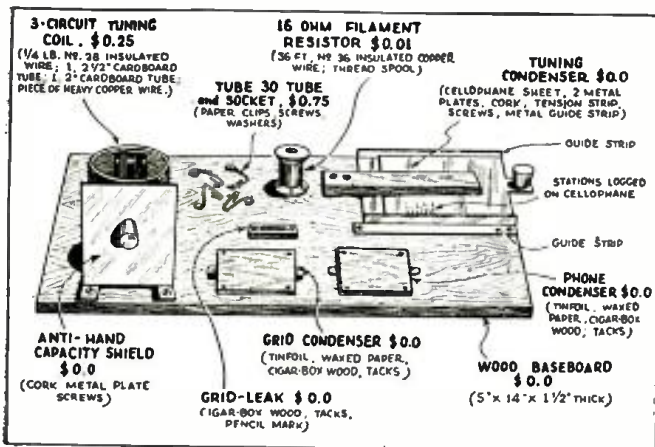

"Build me the simplest possible radio receiver," was the order that came down the line from the Big Chief, who continued, "Just imagine yourself on a desert island with only a standard radio tube and little else for constructing the set." We here present to the beginner in radio a set built under these "Robinson Crusoe" conditions. It picked up programs from Dallas, Texas, 1,500 miles away, the very first night!

WE HAVE always with us, a very large class of those who get a tremendous amount of satisfaction from accomplishing something that the other fellow can't do so well. Also we have a large class of those who take nothing for granted but wish to be their own bosses when it comes to certain accomplishments.

Now a days, things are made pretty easy for those who wish to build a simple radio set, but suppose you were on a desert island or in a very small community where you could not buy the parts that go into a radio set; or suppose you were a young man or a shut-in with very little money with which to buy certain parts. What kind of a radio set could you build?

Then, also, not so many months ago, a children's cyclopedia made a request to the editor of this publication for a very simple radio set that any boy could build, from things easily obtainable. Strange to say, he could not produce such a set for them on short notice *simply because none had ever been built.*

All this brings us to the question, what is the simplest radio set that can be built and also the cheapest?

The editors have given this considerable thought and experiments have produced the present beginners' set which should fill the bill handsomely. It is, in fact, so simple, that with the exception of the radio tube, *everything* is made from junk and parts that can be found in any house. Yet, with all, the set actually brings in distant stations from all over the country. There has been no idea to perfect anything on this particular set. It isn't intended to compete with the set that uses standard parts, to be sure. It is just a stunt to show what can be done with practically nothing and should be welcomed by those youngsters from 8 to 80 who wish to accomplish the impossible with very little

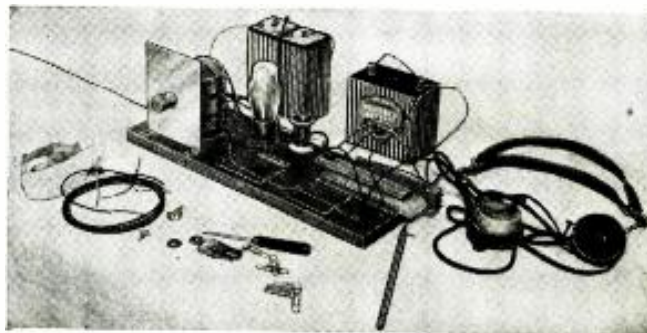

means. To those the present set has been dedicated.

Prime Requisites of a Good Set

Any radio set worth its salt should have the following characteristics:

- (1) Absolute minimum cost of parts.
- (2) Sufficient selectivity to separate powerful local stations, yet sensitivity enough to give the beginner plenty of distance (DX)

thrills.

- (3) Easy to construct and operate.
- (4) Minimum operation expense.

Making use of odds and ends (some of them new to even dyed-in-the-wool hams); and using a little ingenuity in putting them together, anyone can build this novel little outfit.

How to Begin

Let's take the set apart and build it up, one step at a time. Easy does it, so we begin on a sawed-off board measuring anywhere from 5x14 ins. (the size used for the set on the cover) to 8x20 ins. Finish it off as finely as you please, or leave it rough. It pays to take pains, though,

and a well-sanded, shellacked base, set aside to dry, gets you off to a good start. Make a layout on a sheet of paper, full size — indicating just where each part is to go. This helps considerably when you wire the set.

The fixed condensers needn't scare you. They are of the "postage-stamp" variety, and are made from waxed paper and tinfoil. Strip the foil from a pack of cigarettes or a tea package and smooth it out on a flat surface with your thumbnail. Cut six pieces, each 1x2½ ins. overall, with the shape indicated in Fig. 2A. Cut eight pieces of waxed paper, 1½x2 ins. For the grid condenser, place a piece of paper on the set base in the front center, then a piece of

(Continued on page 560)

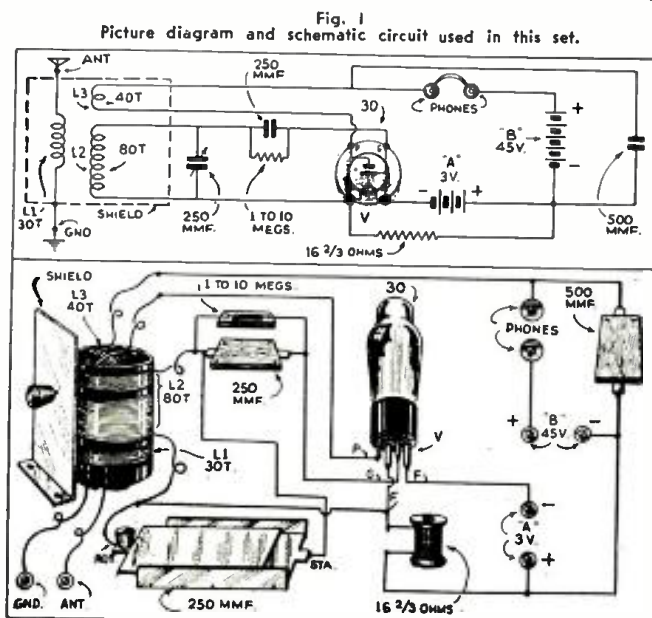

THE EARLIEST LOUDSPEAKERS

The French magazine, *La T.S.F. Pour Tous* recently published this interesting article on the early experiments in voice transmission which paved the way for modern loudspeaker development... We are reprinting the data especially for radio beginners.

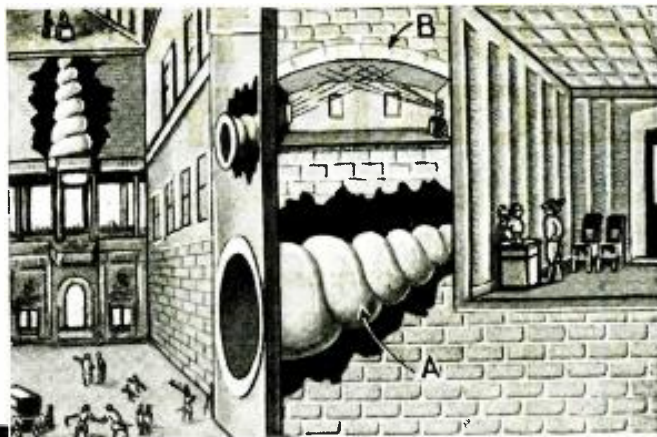

Fig. A
A giant loudspeaker of 1650—reproduced from an engraving in Kircher's book.

WHEN we speak of "loudspeakers" we generally assume the adjective "electrical" because we have in mind a device operated by an electric current having the frequency of sound. This device is probably as old as the invention of the telephone.

There are, however, other than electric loudspeakers and since time immemorial thought has been given to develop devices intended to steer the human voice in a certain direction and thus obtain an apparent amplification which allows it to be heard at a greater distance and by more listeners.

A study of the ancestors of present-day loudspeakers has not only a purely historical interest; it may offer to the research worker certain technical facts which should not be rejected "a priori."

The theatres of antiquity were of the open-air type and had no roofs, though they were provided with a "Velarium" intended to protect the spectators from rain and sunshine. The acoustics of these ancient theatres could have been admired by our modern architects and the principles, probably empirical with the ancients, are still applied in the construction of the modern

talking picture houses and concert halls.

Disregarding this fact, the voices of the actors were not strong enough to be heard by the entire audience of the great theatres and the technicians of those days searched for some means of voice amplification. The Greek and Roman actors, the same as the Chinese, used masks provided with bronze mouth openings, and it has often been supposed that these masks amplified the voices. It is certain that the main function of these masks was to give to the presented type the same appearance during the entire play. Often when the actor had to sing or to speak, metal masks were used with wide-open mouths while in pantomimes masks with only slightly open mouths were employed.

Within the past few years have been found examples of the so-called "Echea" in the ruins of theatres of antiquity. These are metal vases of a conical shape, which were placed with their openings toward the scene. They were grouped in two or three lines, 13 units per line, each line evenly divided by them into 12 parts. These vases were there for acoustical reasons and according to the contemporaries served to amplify the voices of the actors. Instead of metal reflectors, sometimes earthenware vases, so-called "Dolia," were used (Fig. 1B). Some authors claim that similar vases were used in many churches in the twelfth and thirteenth centuries and were intended to amplify the preacher's voice.

One of the first books on acoustics was published in 1650 by the German Jesuit Kircher (*Musurgia Universalis*) "A Treatise of Universal Harmony." In this book, Kircher, who was an all-around scientist for his time, tells that the soldiers at Alexandria used voice amplifiers made of spiral-shaped zinc tubes and that their voices could carry over several kilometers. This fact has to be proven; however, the drawings of his book give very interesting details. Let us take, for instance, the drawing shown in Fig. A. Here is shown a way in which the human voice could be heard at a great distance when a very long acoustic tube was used and when this tube which was particularly shaped was terminated in a wall (which acted

(Continued on page 558)

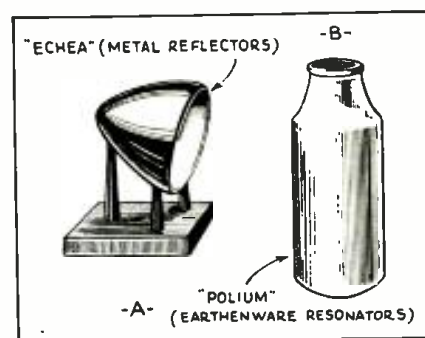

Fig. 1
The "echea" at A and the "polium" at B.

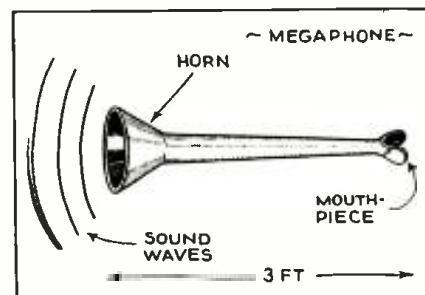

Fig. 2, above
The early ancestor of the horn-type speaker in the form of a megaphone used to instruct sailors on shipboard.

Fig. 3, below
The hornless magnetic speaker built in 1879 by Elisha Gray.

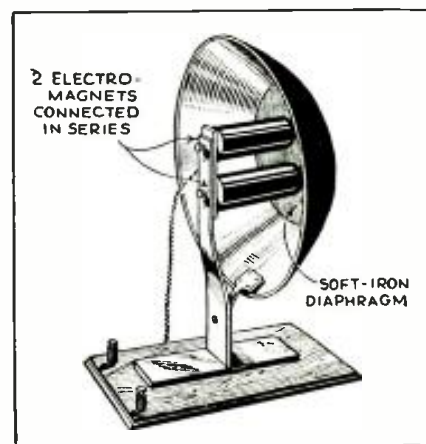
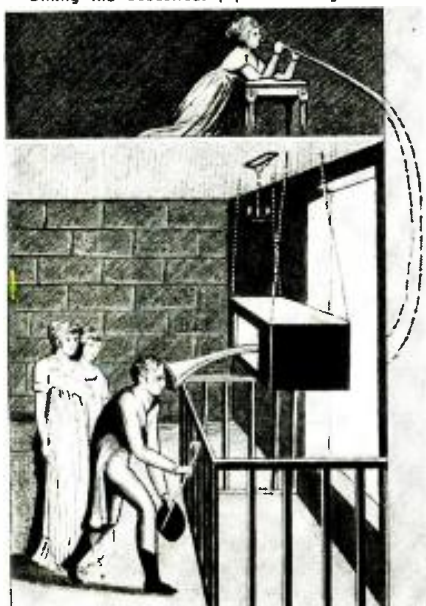

Fig. B
The "mysterious box" or "invisible singer" combining the acoustical pipe and large horn.



MODERN THEORY OF ELECTRICITY

When radio beginners attempt to grasp the entire theory of electricity at one sitting, they become hopelessly confused. It is the purpose of this series of discussions to lead our readers along in easy stages, until they really grasp the principles.

PART I

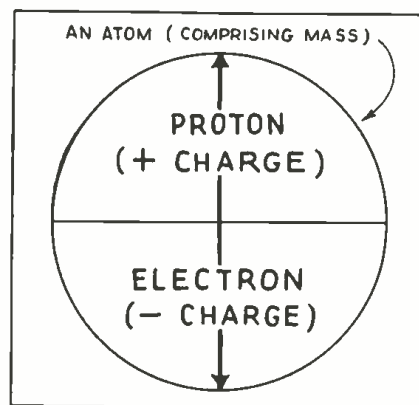

Fig. 1
Electrical constituents of an atom.

THE NATURE of electricity is not really understood, any more than the nature of thought.

Electricity is an unseen force. Its presence is known by its actions. Yet a great deal more is known than was the case twenty years ago, and fresh discoveries are being made every day.

The modern theory of electricity is termed the "Electronic Theory." This is not so difficult to understand as it sounds, and is of the greatest possible help in explaining the action of tubes and other electrical phenomena. Our present theory concerning the structure of the atom completely sums up all known facts concerning electricity.

Scientists may form a mental picture of an atom to help them to explain one electrical phenomenon, which may be quite inaccurate for dealing with another problem, and a new mental picture of the atom may have to be adopted.

The reader must realize that it is impossible to indicate in a few paragraphs all the difficulties and limitations met with in the study of "Molecular Physics," but a brief summary of some of the modern conceptions of the constitution of atoms may enable him to get a good idea of what is occurring.

For the student to thoroughly comprehend the "Electronic Theory" and its application in radio and sound equipment he must stop to study a little radio history which will date back in this case to the late Thomas A. Edison. As you will remember he was the inventor of the incandescent electric lamp, made luminous by heat, the first of its type being commonly known as the carbon filament lamp. This became very popular as the method of illumination and was then used extensively in offices and workshops. Although this lamp was the greatest gift to mankind its uses were limited to illumination. In other words, just another light. We will now turn our attentions to Prof. J. S. Fleming of England, who watched with interest the dark film that began to collect on the inside of the glass bulb after the lamp was used, and nearing the end of its normal life. This film that collected cut down the candle

Service Men— Do Your Duty!

You old-timers are apt to consider this issue of RADIO-CRAFT too elementary to be worthy of your notice. However, bear in mind that every beginner today is a real prospect for your services tomorrow. Some of these new fans, once they get a good start, go places fast. So be good business men, and give them a real hand. Don't be intolerant at their lack of technical knowledge. Instead explain to them, in simple language, the things they want to know—or, refer them to this "Beginners' Number" of RADIO-CRAFT. Please each of these men just once, and watch him and his friends come back for more. Come on! Let's go!

power of the lamp which naturally lost its efficiency and had to be replaced.

Professor Fleming analyzed the film coating and found it to contain carbon. He supposed that the carbon was given off by the filament, when the lamp was in use, and with further experiments he proved that when the carbon filament was hot it liberated minute particles of carbon that collected on the glass walls of the lamp. This phenomenon was, however, invisible in its action, but in time showed tangible clues of what was taking place in the lamp when the filament was hot.

This discovery opened the gates to unlimited possibilities regarding its use, and revolutionized the whole science of radio.

It will now be necessary to investigate these small particles, to find out their reasons in allowing themselves to become detached from the body of the filament and travel into space.

Matter. The students must first of all understand that *matter* is anything that occupies space and has weight. The three forms of matter known to us are under the following category:

Solids—such as steel, iron, wood, wax, porcelain, paper, etc.

Liquids—such as water, mercury, oils, etc.

Gases—such as hydrogen, oxygen, air, coal gas, etc.

The construction of matter is fairly well understood. Matter is composed of myriads of distinct or separate particles, with spaces between them. These particles are termed molecules.

There are as many different kinds of molecules in the universe as there are different kinds of substances.

The Molecule. A molecule is the smallest portion of any substance which cannot be subdivided further without its properties being destroyed. It is the smallest complete and normal unit of any substance.

The Atom. The molecules are made up of smaller particles called atoms. An atom is the smallest unit particle into which matter can be divided by chemical separation.

A molecule may consist of one, two, or more atoms of the same kind, or it may consist of two or more atoms of different kinds.

Thus two atoms of hydrogen (H) will combine to form a molecule of hydrogen (H₂). Two atoms of hydrogen and one atom of oxygen will combine to form one molecule of water (H₂O). The number of atoms in a molecule varies with the substance. In a molecule of salt there are two atoms, in a molecule of alum there are about one hundred atoms, etc.

Different kinds and combinations of atoms can be arranged in an endless variety of ways to form different substances—different kinds of matter. It is believed that there are no more than 93 different kinds of atoms; and molecules of all known substances consist of combinations of these atoms. The next consideration is the construction of the atom.

One conception of an atom is as a nucleus, charged with positive electricity, around which revolve in fixed orbits negative electrons, as planets around a central sun.

An atom is thus pictured as comprising from one to a number of electrons
(Continued on page 557)

REPLACEMENT STATUS OF THE NEW TUBES

H. M. NEUSTADT*

The beginner in radio who has been stumped by the numerous tubes now available will find this article an invaluable aid in learning just how they are intended to be used.

PART I

MENTAL indigestion is likely to be the reward of anyone who tries to assimilate all at once the names and functions of the large number of receiving tube types which confront the beginner in radio today. To the experienced radio man, the problem is not so difficult because he has been able to acquaint himself with tubes as they came along, a few at a time. But among those who are starting from scratch, it seems to be a common practice, as a means of breaking up the indigestible mass of available information, to think of the newer tube types merely as improvements on earlier types. This idea is proper to a certain extent and can be a valuable aid to memory; but it should be emphatically noted that new tube types are improvements meant to be used in new sets. The general idea that new types are meant to be used to replace the tubes in sets designed for earlier types is a mistake and one to be avoided.

It should furthermore be remembered that reputable tube manufacturers do not permit earlier types to stagnate, but take advantage of progressive manufacturing improvements to keep tubes of earlier designs up to date. Thus today practically all tube types are made with copper side rods to reduce grid emission. This, and many other improved constructional details do much to keep the older tube types on a par with the performance which can be expected from new tube types under the same circuit conditions.

While earlier tube types are not in general interchangeable with newer tube types there are some cases which

arise more or less by accident, where a new type tube can be substituted without harm to the new tube or the set for a tube of an earlier type. Sometimes better performance results, sometimes not. Sometimes the new type can be placed directly in the socket, sometimes adapters are necessary. Sometimes there are only minor or no circuit changes required, sometimes the necessary changes are very difficult and expensive. These questions of performance, adapters, and circuit changes will be taken up in following articles but as an introduction to those subjects it may be helpful to the beginner to describe some methods for classifying tube types. It is necessary, of course, to be able to identify tubes before their interchangeability can be discussed.

One helpful factor in the situation is the new tube-numbering system. See Table I.

This system was standardized by the Radio Manufacturers Association in 1933 and since it is a helpful scheme for classifying tubes, it is a good thing to understand. With this system, only three symbols are ordinarily required to identify a tube: a numeral, a letter, and another numeral. The first numeral indicates the filament or heater voltage. Thus, the numeral 1 is used for 2-volt tubes like the 1A6, 2 is used for 2.5-volt tubes like the 2A3, 6 is used for the 6.3-volt tubes like the 6A6, and so on.

The letter distinguishes one type from another which has the same numerals. Thus the letter in the type number is the only thing which distinguishes between the identifying numbers of the 6A6, 6C6 and 6D6. These letters are assigned in alphabetical sequence, start-

Class of Tube	2.5V. Heater	6.3V. Heater
Super Triode	56	76
R. F. Pentode	58	6D6
Pentode Detector	57	6C6
Power Pentode	2A5	42
Twin Triode	53	6A6
Pentagrid Converter..	2A7	6A7
Duplex-Diode Triode..	55	85
Duplex-Diode High-Mu Triode	2A6	75
Duplex-Diode Pentode	2B7	6B7

ing with A for all tubes except rectifiers, for which the assignment is made starting with Z, and working backward.

The last numeral indicates the number of USEFUL elements brought out to terminals. Thus, the 2A5 has five such "useful" elements: a heater, a cathode, two grids, and a plate. The suppressor is not brought out and therefore is not counted.

Remembering this system, it is often possible to figure out something about a tube from the type number. For instance, the 2A3 must have three "useful" elements brought out to terminals. The tube is almost certainly not a rectifier because of the letter. It must there-

(Continued on page 557)

Table I

INDEX OF TYPES BY USE AND BY CATHODE VOLTAGE

Cathode Volts	Power Amplifiers	Voltage Amplifiers Including Duplex-Diodes	Converters in Superhets.	Detectors	Mixer Tubes in Superheterodynes	Rectifiers	Cathode Volts
1.1		11, 12		11, 12			1.1
1.5		26					1.5
2.0	19, 31, 33, 49	30, 32, 34	1A6, 1C6	30, 32	1A6, 1C6, 34		2.0
2.5	2A3, 2A5, 45, 46, 47, 53, 59	2A6, 2B7, 24-A, 27, 35, 55, 56, 57, 58	2A7	2A6, 2B7, 24-A, 27, 55, 56, 57	2A7, 24-A, 35, 57, 58	82	2.5
3.3	20	22, 99		99			3.3
5.0	112-A, 71-A	01-A, 10, 112-A		00-A, 01-A, 10, 112-A		5Z3, 80, 93	5.0
6.3	6A1, 38, 41, 42, 79, 89	6B7, 6C6, 6D6, 6F7, 36, 37, 39-41, 75, 76, 77, 78, 85	6A7, 6F7	6B7, 6C6, 6F7, 36, 37, 75, 76, 77, 85	6A7, 6C6, 6D6, 6F7, 36, 39-41, 77, 78	1-v, 94	6.3
7.5	10, 50					81	7.5
12.6						12Z3	12.6
25.0	43					25Z3	25.0
30.0	48						30.0

HOW TO READ RADIO DIAGRAMS

One of the greatest difficulties that beginners encounter is understanding the wiring diagrams which accompany the instructions for making every receiver. These schematic circuits as they are called, are not nearly as difficult as they seem if they are taken apart and studied piece-meal. This article will help the beginner to get started.

R. D. WASHBURNE

SCHEMATIC circuits are the 'shorthand' of the technician. By their use he is enabled to tell at a glance the manner in which various electrical units may be connected; and, approximately, the effect which one unit will have on another. The symbols in a diagram are the simplest possible representation of the various components of the circuit."

The above quotation from the writer's book "Modern Radio Hookups" tells in a few words the entire purpose of radio symbols—to attempt to present a schematic circuit in mere words without recourse to them would be so short-sighted as to border on the ridiculous. Since the budding radio man (or woman) cannot expect to "get anywhere" without a working knowledge of the more commonly used "shorthand marks" of the technician, we present a compilation of representative symbols, showing both the physical appearance of the unit and its symbolic equivalent as used in drawing up diagrams. The following short discussion will partially analyze the components represented in the numbered sections of the chart. After a little study of this material the beginner in radio should feel not the slightest hesitancy in analyzing the more simple schematic circuits appearing elsewhere in this and subsequent issues of RADIO-CRAFT. With these words of introduction we present the following symbol analyses and RADIO-CRAFT Chart of Radio Symbols.

(1) Aerials are many and varied in their physical appearance and arrangement, but in general the form shown under "symbol" is used to represent that portion of the wire extending from the radio set that is most effective in picking up the radio signal, whether it is a broadcast program or a point-to-point contact. Particular types of aerials often carry specialized symbols and where the actual signal pickup portion ("flat top" under "physical") of the antenna is at a remote point we often find that the lead wire or "lead-in" from antenna to receiving set is of individualized type—thus, for instance, it may be a transposed lead-in or shielded lead-in, and in either instance be represented by individually distinguishing symbols.

(2) For certain types of work as, for instance, in locating sources of interference it often becomes desirable to use a concentrated and portable type of antenna. One of these is the "pancake" type (illustrated) made as a flat spiral of wire.

(3) A connection to the earth (most conveniently afforded by connection to a water or gas pipe) is indicated by a series of parallel lines of decreasing length. (In general, this represents the point of lowest voltage in the circuit.) The same symbol also is often used to represent the metal chassis.

(4) Connections made to screw-type binding posts are readily distinguished from connections made by plugging a telephone tip into a tip-jack.

(5) Two short, parallel lines represent the two pieces of metal foil separated by paper, mica, or other dielectric (insulator) that comprise most fixed condensers. Units of the electrolytic type, in which the dielectric is nothing more than a "skin" of insulating metal oxide, is recognized by the plus or positive mark used to indicate the high-voltage or positive side of such oxide-coated "polarized" condensers.

(6) Where the metal plates of the condenser are adjustable or variable in their relation, the fact is indicated in the schematic circuit by means of a diagonal arrow (or, less often, a curved plate to represent the rotor section).

(7) For quick, convenient connection from one unit to another it is customary to use a plug-receptacle or "jack." Numerous types are available but, in general, the fundamental design is the same—a series of parallel leaves provided with contact points that close or open, as the case may be, when the plug is jabbed into position. The immemorial appearance of headphones is readily recognized in the symbol showing two circles joined by a half-moon section (the headband).

(8) When the beginner first sees the symbol for a condenser block he should not become panic stricken—the long, unbroken heavy bar merely indicates the common or grounded sections of metal foil of the several condenser sections comprising the "bank" or block.

(9) The appearance of a coil of wire is readily recognized in the symbol if we consider that the wound coil has been stripped of the form on which it was wound. Where the coil has been wound in sections we find that the symbol too, is "wound" in sections (9B).

(10) If two or more coils are placed in proximity to each other the fact is indicated by the relative positions of the two or more coils. The physical and symbolic figures indicate that the primary has less turns than the secondary. Thus a voltage step-up ratio is indicated.

(11) One of the most interesting radio devices operates on the principle that a variation in the coupling relation of two coils connected together will change the overall electrical value or "inductance" of the coil. The most convenient mechanical arrangement is to wind one coil on a form that will rotate within an outer form carrying the second half of the wire. Crossed coils, with two ends connected, represent this "variometer" at a half-way setting.

(12) A great deal can be done without the radio man ever seeing a meter, but on the other hand far more can be accomplished with an instrument that will accurately indicate the amount of voltage and current existing in radio circuits. The case of the meter is represented by a circle. The letter enclosed with the circle indicates the type of measurement for which the meter has been designed—thus, M for milliammeter, V for voltmeter, etc.

(13) An audio-frequency winding ordinarily incorporates an iron core. Thus we find iron-core choke coils to be nothing more than a coil of wire with parallel lines (iron laminations) within or alongside the winding.











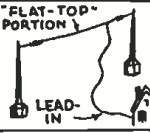



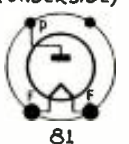





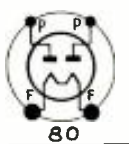





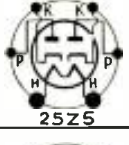



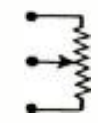

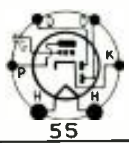
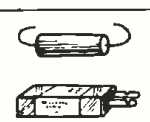
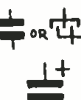

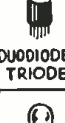
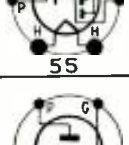



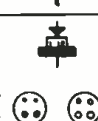

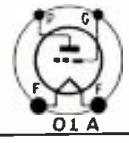



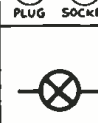





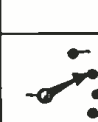

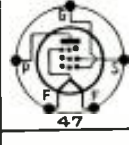
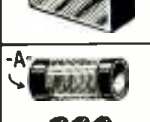
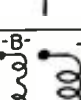
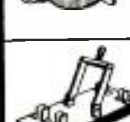

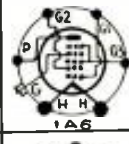

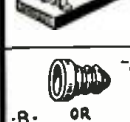
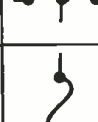

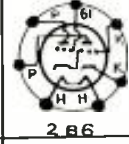

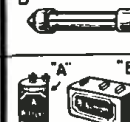
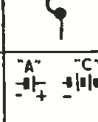
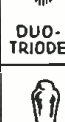
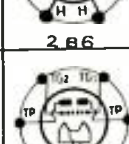
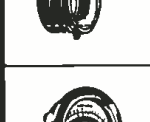
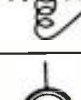

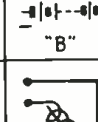
(14) The inductive coupling relationship represented for R.F. or radio-frequency coils (and thus constituting an R.F. transformer) by item 10 is equally applicable to audio-frequency or A.F. coils and is indicated, as an A.F. transformer, by two coils common to which is an iron core (parallel lines).

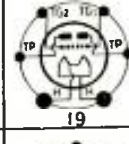
(15) Practically all radio devices designed for power-line operation terminate in a 2-prong plug that fits into a wall receptacle. This relationship is evident in the symbol.

(16) The resistive effect in a resistance unit is clearly

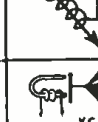
(Continued on page 559)

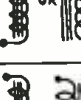
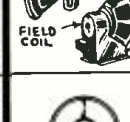
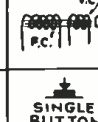
Chart of Radio Symbols

PHYSICAL	DESCRIPTION	SYMBOL	PHYSICAL	DESCRIPTION	SYMBOL	RESPECTIVE TYPES OF TUBES	
	-1- AERIAL			-15- POWER-LINE PLUG PLUG RECEPTACLE			2-ELEMENT, DIRECT-HEATER, HALF-WAVE RECTIFIER. 
	-2- LOOP ANTENNA			-16- FIXED RESISTOR			DIODE 3-ELEMENT, DIRECT-HEATER, FULL-WAVE RECTIFIER. 
	-3- GROUND			-17- VARIABLE RESISTOR (RHEOSTAT)			DUODIODE 5-ELEMENT, INDIRECT-HEATER, DUAL-PURPOSE OR VOLTAGE DOUBLING HALF-OR FULL-WAVE RECTIFIER. 
	-4- BINDING POST			-18- VOLTAGE DIVIDER (POTENTIOMETER)			TWIN-DIODE 6-ELEMENT, INDIRECT-HEATER, DUAL-PURPOSE AMPLIFIER AND DETECTOR. 
	-5- FIXED CONDENSERS ELECTROLYTIC CONDENSER			-19- WIRES NOT CONNECTED			DUODIODE-TRIODE 3-ELEMENT, DIRECT-HEATER, AMPLIFIER, OSCILLATOR OR DETECTOR. 
	-6- VARIABLE CONDENSER			-20- CRYSTAL DETECTOR			TRIODE 5-ELEMENT, INDIRECT-HEATER (SCREEN-GRID) R.F. AMPLIFIER. 
	-7- FILAMENT-CONTROL JACK			-21- SWITCH (POWER OR FILAMENT-SINGLE-POLE, SINGLE-THROW SW.)			TETRODE 4-ELEMENT, DIRECT-HEATER, A.F. AMPLIFIER. 
	-8- CONDENSER BLOCK			-22- SINGLE-POLE MULTI-THROW SWITCH			PENTODE 6-ELEMENT, DIRECT-HEATER, DUAL-PURPOSE, FIRST-DETECTOR AND OSCILLATOR. 
	-9- R.F. COILS (MAY BE R.F., CHOKE)			-23- DOUBLE-POLE DOUBLE-THROW SWITCH			PENTAGRID CONVERTER 6-ELEMENT, INDIRECT-HEATER, DIRECT-COUPLED A.F. AMPLIFIER. 
	-10- R.F. COILS COUPLED (R.F. TRANSFORMER; STEP-UP RATIO)			-24- FUSE			DUODIODE 5-ELEMENT, DIRECT-HEATER, CLASS B, A.F. AMPLIFIER. 
	-11- VARIOMETER (CONTINUOUSLY VARIABLE R.F. COIL)			-25- CELL AND BATTERIES			TWIN-TRIODE 7-ELEMENT, INDIRECT-HEATER, DUAL-PURPOSE DETECTOR AND AMPLIFIER (OR OSCILLATOR). 
	-12- METER (MAY BE VOLT METER; AMMETER; OHMMETER; MILLIAMMETER, ETC.)			-26- PHONOGRAPH PICK UP			PENTODE-TRIODE 7-ELEMENT, INDIRECT-HEATER, DUAL-PURPOSE, AMPLIFIER AND RECTIFIER. 
	-13- AUDIO FREQUENCY COIL (MAY BE A.F. CHOKE)			-27- MAGNETIC SPEAKER DYNAMIC SPEAKER			MICROPHONES (CARBON)
	-14- TRANSFORMER (MAY BE A.F. TRANSFORMER, PWR TRANS. OR FILAMENT TRANS.)			-28- MICROPHONES (CARBON)			DOUBLE BUTTON

FAMOUS 1-TUBE CIRCUITS

Here they are—the foremost old-time diagrams on parade for the radio beginner! Take your choice of circuits that thrilled dad!

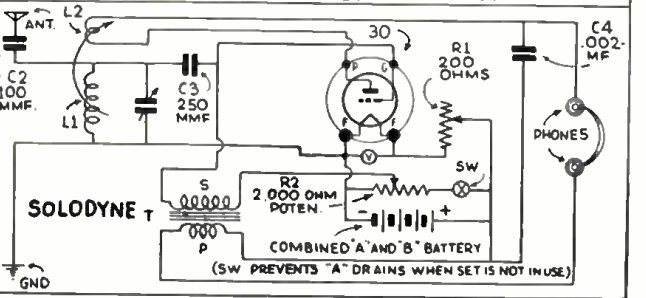
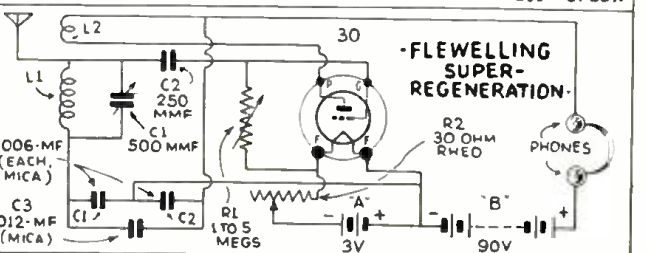
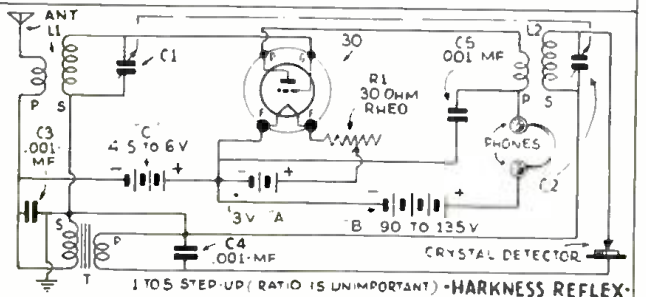
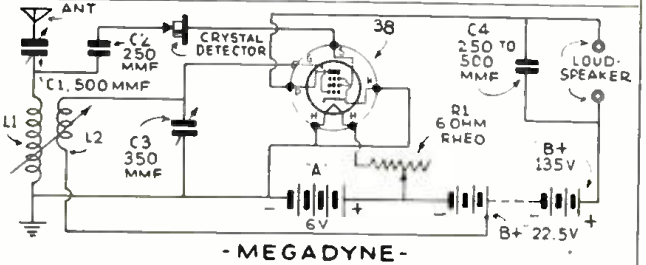
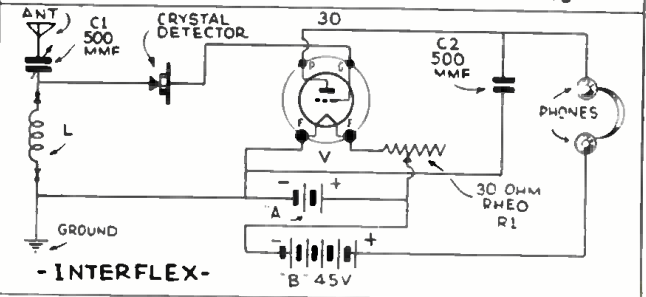
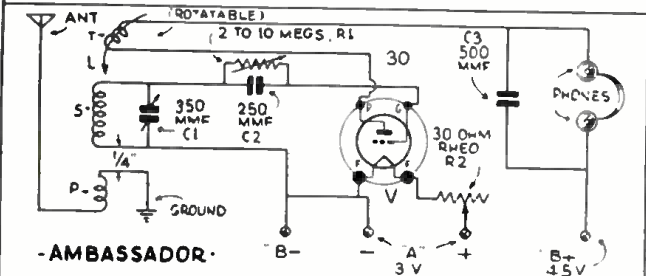
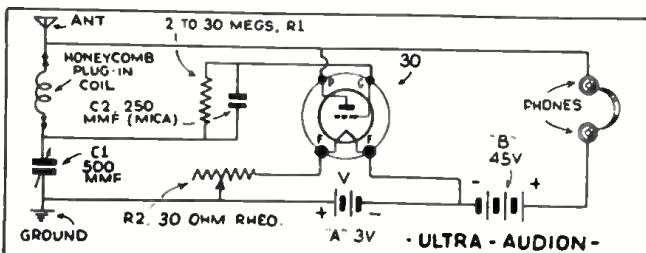

ULTRA-AUDION. Undoubtedly, the most publicized circuit in radio is the Ultra-Audion—the probable genesis of the regenerative circuit. All-wave operation, from 'way down to approximately 30,000 meters, may be secured using a set of plug-in coils and only one tuning condenser.

AMBASSADOR. Without question, the receiver that longest held the spotlight of popular interest was the Ambassador or "3-circuit tuner" receiver. A judicious choice of turns and degree of fixed coupling between coils P and S, and adjustable coupling between T and S, results in any desired degree of selectivity and regeneration control. Winding data: S, about 65 T., No. 20 D.C.C. wire on a tube 3 ins. in dia.; P, about 5 to 15 T., No. 20 D.C.C. wire (same winding direction as S; spacing, about 1/4-in.); T, about 25 T. No. 28 D.C.C. wire of a tube just small enough to rotate inside S.

INTERFLEX. Some years ago Hugo Gernsback conceived the idea of confining to a crystal detector the rectification action in a receiving circuit, and using a vacuum tube as an A.F. amplifier—*coupling detector to tube without a transformer*. In this manner considerably greater volume was secured from a 1-tube, non-regenerative receiver. It is particularly important that the "A" and "B" batteries be connected as shown. Incidentally, the Interflex illustrated is ideally suited as a high-fidelity receiver.

MEGADYNE. Of special interest to the technician is the Megadyne circuit which utilizes a type 38 R.F. pentode in preference to a triode (the 30, for instance). Note that the use of a crystal detector in the grid circuit of a vacuum tube as used in the original Interflex has been retained by Hugo Gernsback in his Megadyne receiver. Follow the schematic circuit *exactly*; the signal is applied to the screen-grid and *not* to the control-grid of the 38. Use only the battery voltage indicated on the schematic circuit. (A grid leak from crystal-grid to filament may improve operation.)

HARKNESS REFLEX. When first introduced the Reflex circuit fired the imagination of the more advanced technicians. But it remained for the Harkness Reflex to establish itself as probably the most outstanding of the 1-tube "jobs." The "secret"—if it be such—whereby the Harkness circuit outperformed other 1-tube reflexes is found in the use of two tuned circuits, comprising "antenna" coil L1 and "R.F." coil L2 and respective tuning condensers C1 and C2 (shown ganged for convenience).

FLEWELLING SUPER-REGENERATIVE. Some years ago it was demonstrated that amplification considerably beyond that which was ordinarily obtainable from a regenerative tube circuit could be obtained by applying a "suppressor" frequency to a tube circuit that had been permitted to oscillate violently. Termed "super-regeneration," the Flewelling circuit was one of the least complicated. A bank of mica-insulated condensers, C1, C2, and C3, and an adjustable grid-leak, R1, do the trick.

SOLODYNE. An importation from England, the Solodyne achieved international prominence as a so-called "battery-less" receiver. However, like the suit of clothes the traveling salesman managed to camouflage into his "swindle" (Continued on page 562)

INTERNATIONAL RADIO REVIEW

THE MOVIE DIAL

NOVELTIES in dials have long been one of the greatest selling points in radio receivers, abroad. Many trick effects have been produced in order to sell a certain manufacturer's receivers, some of which we have mentioned on this page.

As we have pointed out before, European stations announce their city or town as a station identification, instead of using call letters, as we do.

In a recent issue of *EUROPA STUNDE*, a German magazine, an interesting version in trick dials appeared. As shown in Figs. 1 and A, this consists of a light, a long tube, a lens, an opaque disc with the names of the stations cut in it radially, and a translucent screen on which the name is projected. Thus, as the set is tuned, the station name appears as the signals are tuned in. The set is also equipped with a regular dial with an indicator.

The ambitious experimenter should be able to duplicate this novelty in dials without much difficulty.

THE RADIO BED

RECENTLY in *RADIO-CRAFT*, we announced a new radio set which attaches to the bed, facilitating bedside radio reception; a luxury which many radio listeners like to enjoy.

In England, now, the radio constructors have gone a step further, actually making the radio receiver as a part of the bed, with the dials and speaker

EACH month there are received at the offices of *RADIO-CRAFT* hundreds of daily, weekly and monthly magazines originating from all over the world.

SINCE the cost of subscribing to each of these would be prohibitive for most radio men, we have arranged with technical translators to prepare for our readers reviews of all the really important, new developments illustrated and described each month in these publications.

NOTE that the only available information is that which is published; the experimenter must adapt the ideas to whatever equipment he has on hand.

mounted inconspicuously in the head. This appeared in *AMATEUR WIRELESS* magazine.

The method of construction is shown in Fig. 2, which includes several varieties. So, all you bed-loving radio fans who would like to hear your favorite programs from the warmth and comfort of your bed, should get busy and make one of these novel installations. The details of the receiver, of course, are left to your own choice.

THE AUTO-SELECTOR

A RADICAL type of radio remote control has just appeared on the European market, according to *RADIO-AMATEUR*, a German magazine. This device, as shown in Fig. B consists of a telephone type dial mounted on a small black box. This dial is marked with the names of cities of 10 of the most popular stations and to tune in any station it is only necessary to put your finger in the desired aperture and turn the dial just as in dialing a telephone number on one of the automatic telephones.

Another small knob on the front of the box permits volume adjustment.

This small control box, with a somewhat larger one, shown behind it in Fig. B, comprises the entire remote control unit which is used with a standard broadcast set. The larger box is installed in an out-of-the-way place in the house and outlets are installed wherever desired.

This method of remote control uses the methods of control utilized in the automatic telephone, such as step-by-step switching, etc.

ARMCHAIR RADIO SET

SEVERAL months ago in *RADIO-CRAFT*, a picture of an armchair set, in the form of a portable case which clamped onto the arm, appeared as the cover illustration.

(Continued on page 569)

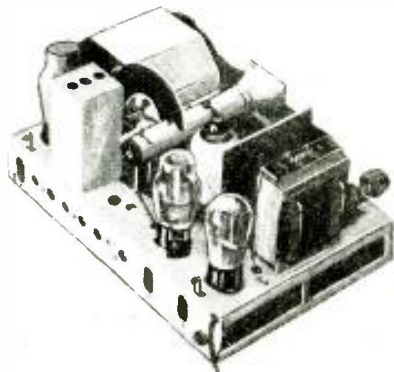

Fig. 1, below
The set-up of parts for the movie dial.

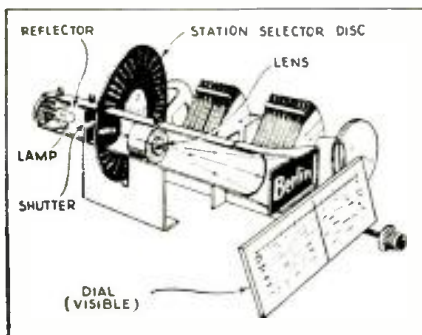

Fig. A, left
The receiver containing the movie dial.

Fig. B, right
A remote control which uses the parts and methods of the automatic telephone, machine switching and selector dial.

Fig. 2, below
Here is one way to be comfortable and still listen to your radio set.

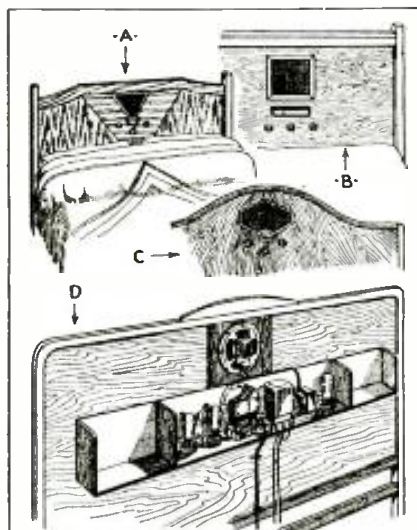

Fig. C, below
An Australian radio receiver in a chair.



RADIO DEBUNKED

In pointing out some of the apparent fallacies and discrepancies in radio, let it be understood that no personalities are intended. It is hoped that any one company or individual which has "been taken for a ride" will take the criticism as constructively as it is intended and not take personal offense.

There is an old saying that "every knock is a boost" and it is hoped that our knocks will turn out to be boosts for all concerned. At any rate everyone will agree that radio terms and advertising can stand a "clean up."

C. W. PALMER



THE RADIO industry, especially that part relating to broadcast reception, is so cluttered up with misconceptions, fallacies, superstitions, etc., that it is high time someone undertook to debunk it. The word "debunk," dear reader, in case you do not know, is a verb used to denote the removal of nonsense or misstatements from anything.

So with trepidation as to the landslide which may descend upon our heads from this debunking, let us start upon our self-appointed task.

The first thought that comes to mind is the myriad of statements and names in radio which are so far from being exact that they force themselves upon the attention of any clear-thinking reader.

Misnomers

How many times have you seen the word "loudspeaker" or "speaker" and wondered why a better word could not be chosen? Obviously, it is not a speaker—it reproduces bands and singers as easily as the human voice. ("Reproducer" is a much better term.)

And this is only one of many such

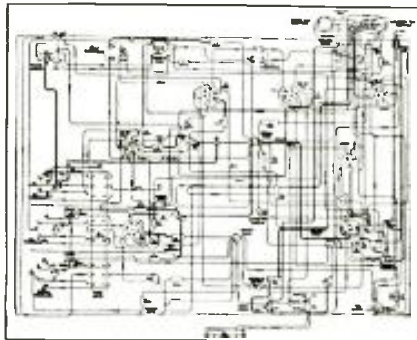

If anything uses more wire in a small space than a "wireless" set, we should like to see it.

misnomers. A condenser does not condense anything—it simply stores up an electrical charge. A vacuum tube cannot truthfully be said to be a "tube" as it is not tubular in shape, except in a very few and isolated instances.

And no doubt you have heard that wretched expression "A.C. current" which written in full means *alternating current*; or, equally as bad, "I.F. frequency" which is *intermediate frequency frequency!* Or if you have

read any of the magazines published across the big pond (in England) you have been amused or perhaps angered by the continuous repetition of the word "wireless." If anything uses more wire than some modern radio receivers, in such a small space, we should like to see it. "Wireless" went out of date, in favor of "radio," "y'ars" ago; (wonder if some folks know the War is over?).

Another term which is most aggravating is the use of the word "dry" in connection with the electrical *cells* used to ring doorbells and heat the filaments of certain vacuum tubes. These chemical cells are far from dry as you can discover by taking one apart (the same fact applies to the "dry" electrolytic condensers). And a single cell does not constitute a "battery" as many writers seem to think—it takes more than one cell to make up a battery. (One prominent battery manufacturer, though, has just introduced a 1½ V. "dry" battery. The term battery is correct in this case as it actually contains 4 cells in parallel. See description in a forthcoming issue of RADIO-CRAFT.)

One must not take radio terms too literally as this sketch illustrates.



You have heard reproducers which are far too "ripe" and more than "half tipsy."



Here is what the maker thinks of his set—and just think it's all for \$15.00.





"What you need is a new set of Super-Ticklish tubes"—the results are just as bad.

Radio "Boners"

Along the same line are such words as *catwhisker*—which neither comes from a cat nor is it a whisker; *resistance-coupled amplifier*—which is not resistance-coupled but rather condenser-coupled, as the resistors simply place a load on the tube elements and permit the direct potential from the battery or "B" supply to reach the plate without short-circuiting the signal current; *static*—which is not static electricity at all as students of physics can easily explain, but rather "atmospherics"—that is, natural or man-made high-frequency disturbances. These currents are very much "dynamic" when amplified by a radio receiver!

And then, there is the term "oscillating set," as applied to a radio receiver. Obviously the set does not swing back and forth or vibrate, it is the parasitic currents in the set which build up in places where they are not desired that cause the electrical oscillations. Words such as this one are insufficient rather than misnomers and there are quite a few heard frequently in conversations pertaining to radio. For example, "superheterodyne" receiver should be *supersonic heterodyne* receiver; and "phonograph pickup" is really *phonograph-recording pickup*.

Advertising Misstatements

But perhaps, these slips in applying names to radio parts and circuits are much less annoying than the obvious misstatements found in some radio advertisements (some of which make the old "shell game" seem tame). How many times have you heard the word "mellow" linked to radio speaker ads? What on earth has mellowness to do with a device which must transmit sound waves to a listener as nearly identical as possible to the original waves emanating from the instruments?

Here is what one dictionary lists to define mellow—"soft and ripe; well ma-

tured; soft to the touch, palate, ear, etc.; genial; half tipsy." You have certainly heard reproducers which sounded far too ripe and almost completely tipsy, but that is surely not what the advertisers had in mind when they described their instruments as "mellow."

The same false idea is conveyed in describing the reproducer as a "musical instrument." It is nothing of the sort. Reproducers (loudspeakers, to you!) are required to reproduce music, but they are just as often required to reproduce noises and unpleasant sounds, such as the sound effects used for dramatic presentations. The reproducer of a radio set is no more a musical instrument than is an open window or door through which you hear music.

Bolognal

And speaking about music, have you noticed the quantities of nonsense in some of the advertisements of vacuum tube manufacturers? "Crystal clear reception with tubes." "His set sounded entirely different as soon as he inserted tubes." "What you need is a new set of Super-Ticklish tubes," etc.

I do not mean to infer or suggest in any way that all makes of tubes are as good as another—they naturally vary. Occasionally when a new tube is substituted for an old one the quality improves, but this is generally due to the fact that the emission of the old tube has decreased considerably and cannot handle the signals without introducing distortion. Provided you use the right type of tube and one with a suitable impedance, the only difference between various makes (in most circuits at any rate) will be in the strength or perhaps in the life of one make over another.

Paging Veracity

One of the simplest ways of loosening the aerial coupling to a receiver is to connect a series condenser in the aerial lead-in. It doesn't matter much how you make the small series condens-

Everyone will agree that a cleaning up of radio claims would do good.



Tone controls (?) do more harm than good—no two people agree on the setting.

er—it can be the ordinary compression type, a variable air condenser or it can be a metal tube with a terminal at each end, one part of the tube sliding within the other, so varying the capacity.

The flights of fancy indulged in with speakers and tubes are nothing compared to the eloquent outbursts which announce some of these aerial condensers. I thought I knew a little about condensers and the effect of placing them in series with the aerial, having used this little kink for a dozen or more years, but those ads certainly taught me a great deal I didn't know before.

The Crowning Achievement

And talking about eloquent outbursts, the following advertisement was composed, printed and mailed to countless unsuspecting radio set buyers by a supposedly legitimate radio manufacturer:

"Steeped in a blaze of glory, adored by millionaire and workman alike, the B..... Radio with its voice of silver and case of gold is the season's sensation. Built, sponsored, and strictly guaranteed by three organizations with combined plant area of fifty-two acres, aggregate experience of over 100 years in manufacturing and merchandising, it challenges the genius of an entire industry. Its power plant is made up of four huge tubes, the latest multi-mu, screen-grid, power pentode and full-wave rectifier, reinforced by specially designed transformers, condensers, and circuits. Its exclusive Dynamic Speaker, the crowning achievement of sound engineers, has an eloquence so sweet and natural it gives new and unheard-of beauties to tone. Its gorgeous cabinet is a matrix of a \$5,000.00 carving from the skilled and talented hand of Everett Worthington, America's foremost product stylist. The standard model shown is done in Studio-Bronze; also others in Antiqued Platinum. The cabinet material, neither wood nor metal, is the latest attain-

(Continued on page 563)

SHORT-CUTS IN RADIO

FIRST PRIZE \$10.00
 SECOND PRIZE 5.00
 THIRD PRIZE 2.50
 Honorable Mention
EXPERIMENTERS: Three cash prizes will be awarded for the best "short-cuts" — time- and money-saving ideas—submitted by readers of RADIO-CRAFT; Honorable mention will be given for all other published items concerning radio and its allied fields.
 Send us your "kinks" right away.

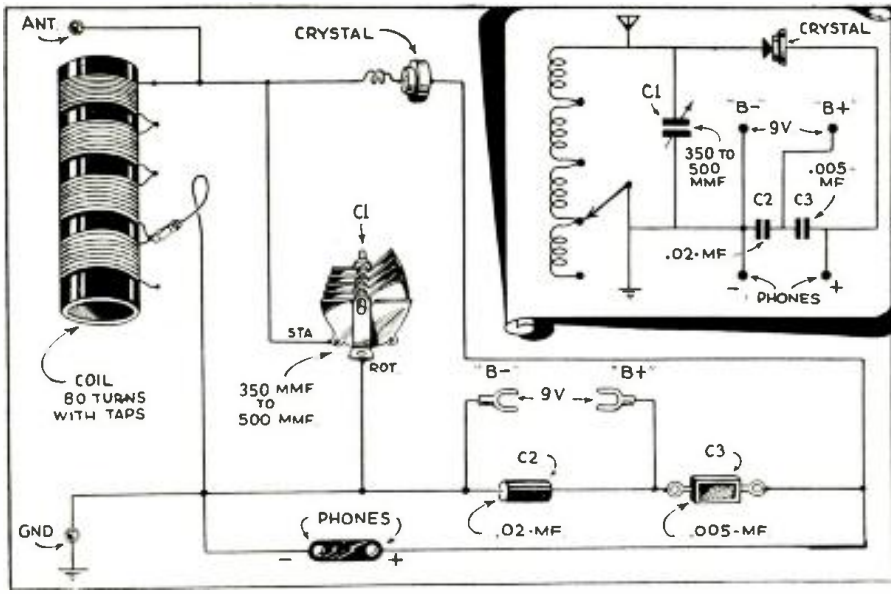

"Battery-ize" your crystal set for increased sensitivity.

FIRST PRIZE

USING a battery in a crystal circuit greatly improves the performance of crystal radio sets, if you know how to go about making the proper connections. Refer to the illustration above for details. The electrostatic charge on the .02-mf. condenser (C2) is converted to a positive current when passing through the tuning coil. It is superimposed upon the positive charge that is starting to be rectified, thus giving tremendous gain of signal strength. The tuning coil is made with a 4 in. tube. Wind on 20 turns of any convenient size wire (No. 14 to No. 28) and make a tap, soldering a connecting lug on to which you can fasten a clip. Or if you want to make a simple switch use brass tacks and a piece of brass as an arm. Then wind on 20 more turns and make another tap, etc., until 80 turns are on the coil. Condenser 1 is an ordinary variable condenser, about

350 mmf., used to tune across the broadcast band.

The use of a small silicon crystal (galena fuses too readily) and pointed copper wire catwhisker will keep the detector circuit resistance at a low value; this will result in increased signal strength and more selective operation. The value of condenser C2 is an important factor.

Almost any "B" voltage may be used but ordinarily 9 V. is about right; higher voltages tend to burn out the crystal at the contact point of the catwhisker.

WALLACE LEIBER

SECOND PRIZE

HERE is a condenser test device which is very useful. A leaky condenser will cause spasmodic operation of the neon tube. A shorted condenser will show a continuous light; an open, no glow; a good unit shows one flash—

discard as poor or leaky if more than 3 flashes. This is a good test with fairly high voltages. It works well with all except electrolytic condensers. Use a 110 V. A.C.-D.C. neon glow lamp.
 JACK GEIER

THIRD PRIZE

SKATE keys are a swell ally of the Service Man if he knows how to put them to use. The illustration shows how the skate key may be "rebuilt" for use as a wrench in turning square-headed bolts and screws. Those who have had occasion to work on some of the early Radiola models will appreciate the value of this idea.

HARRIS L. WRIGHT

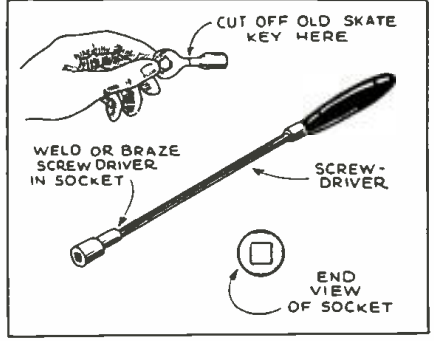

Above, "Johnny had a" skate key but now it's a radio tool.

1ST HONORABLE MENTION

AS EVERY radio man has discovered, changing 6- and 7-prong tubes in their sockets is a nerve wracking procedure—a little misalignment and too much pressure and away goes a flimsy socket. However—making a check mark

Below, identifying tubes as to their type and position aids the nerves.

An inexpensive condenser testing unit for the service beginner.

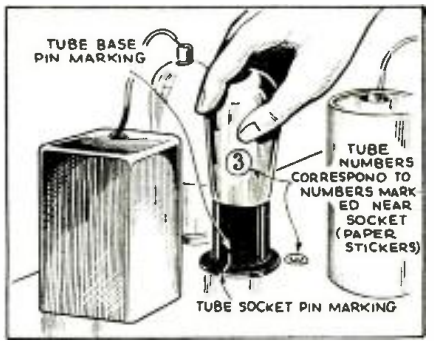
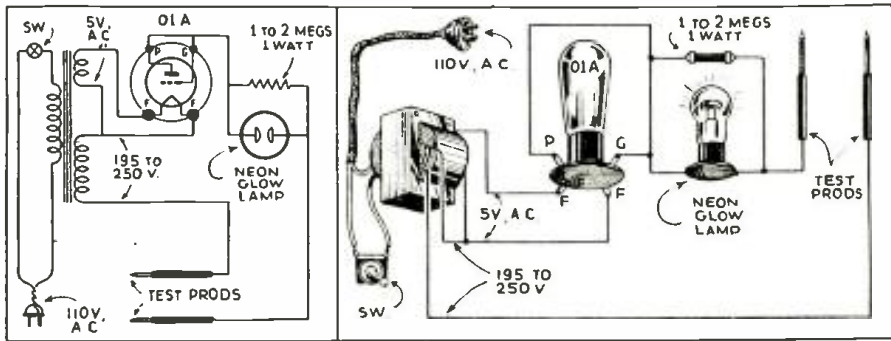

on the tube base before removing it from its socket and another mark on the socket mounting, as shown above, eliminates this trouble. Also, identifying each tube in the set by means of marked pasters will greatly speed subsequent service.

WALTER E. KEEVER

2ND HONORABLE MENTION

MANY times old "B" batteries are discarded without thought of possible uses for them. Like lots of other radio parts, there are uses for them if you use some ingenuity and a little thought. This idea has real merit, and should appeal to those who like to tinker with the family radio, or to Service Men everywhere. Insulated tools such as pliers and screw-drivers are fairly expensive, but almost a necessity for much radio repair work. You can easily insulate your tools with an old "B" battery! Take it apart and put the sealing compound in an old can. Melt it and dip your tools in. See Fig. 1. Dipping several times, one coat on top of another, gives the tool a good thick coat of surprisingly high dielectric strength. When the coating is thoroughly dry, scrape the compound from parts you want exposed—and there you are.

F. C. LEOFFLER

3RD HONORABLE MENTION

A NOVEL stunt which makes it possible to reclaim many faulty potentiometers of the moulded type is this: Remove the control and examine

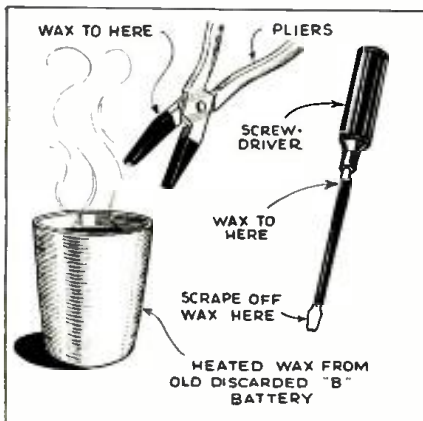
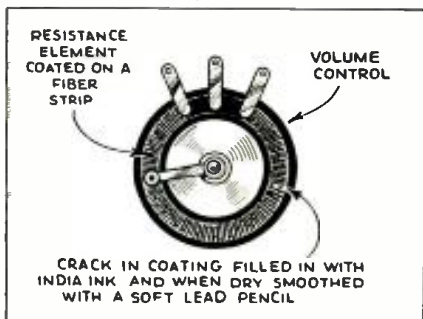

Fig. 1, above; "B" batteries insulate tools.

Fig. 2, below; volume-control repairs.



the resistance element to find out if there are any cracks in it. Often this is evident and the only thing wrong with it. Use a pen and some india ink, and fill up the crack. See Fig. 2. When it is dry, simply rub it lightly with a soft lead pencil. The resistance of the pencil mark makes a fine substitute for the original element.

JOSEPH KWACZ

4TH HONORABLE MENTION

MANY kinds of electrical devices require small multi-point switches for proper control. Usually it is necessary to drill holes in the panel itself, and devise some method of securing the switch arm. Here is a stunt which not only works, but works smoothly and easily. You can make up as many switches of this type as you desire, with a different number of contact points on each. They are easily interchangeable. This is how to make tap switches out of old volume controls, the kind with a 2 1/4 in. bakelite case. Holes for as many taps as required are drilled to receive the machine screws A; B are counter-sunk holes made by drilling with a 1/8-in. drill, 1/8-in. deep. D is a piece of brass 1/8-in. wide and 1/2-in. long shaped as shown. This is soldered under the movable contact C so it will drop into holes B when the contact arm is over the points A. This is a non-shorting type switch, (Fig. 3A).

Fig. 3B shows how to make a shorting type. A strip of brass 1/8-in. wide and about 3/4-in. long is shaped like F and soldered under the sliding contact so it must be long enough to reach two contacts at the same time. A strip of brass E is soldered exactly opposite the sliding contact and the wedge-shaped piece D is soldered under this to drop into the holes B to make a positive stopping point when the contact F is directly over one contact A.

H. W. GALLES

5TH HONORABLE MENTION

WE AMERICANS are inclined to feel that we have a corner on the "kinks" idea. As a matter of fact, our foreign cousins are every bit as resourceful when it comes to doing things with meager equipment. This is from Mexico. We all know good methods of bending aluminum for chassis construction and what to do with old tubes and gadgets. But how to cut square and rectangular holes in a chassis for mounting transformers and condenser blocks is a problem. Here's a good way and it makes a neat job, shown in Fig. 4. Mark out the rectangle and score it deeply with a sharp tool. Then drill a hole in the center the size of one dimension. Square it up for a short distance with a file, just so a hacksaw blade gets a good grip. Saw both sides to the ends and then bend the pieces back and forth until they snap off. Smooth the edges with a file and the job is done.

EMIL W. STREULI

(Continued on page 567)

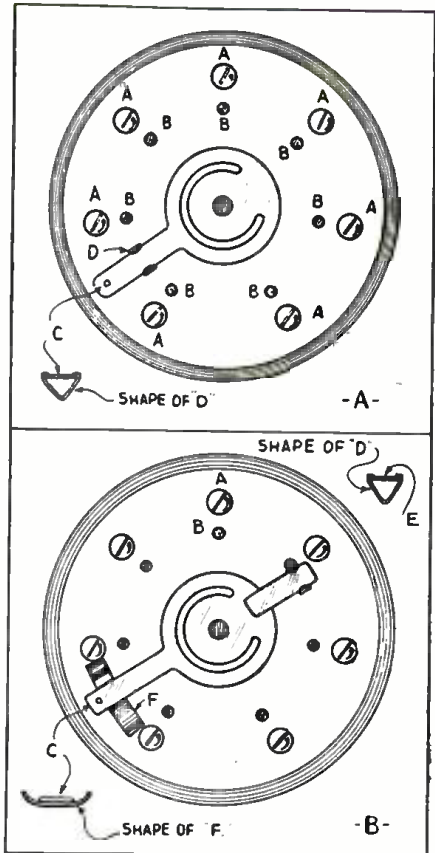

Fig. 3. Neat multi-point switches.

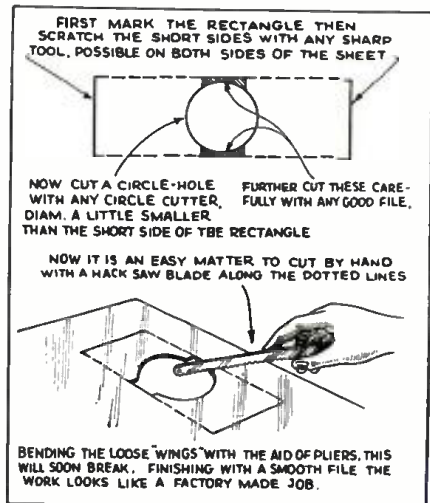
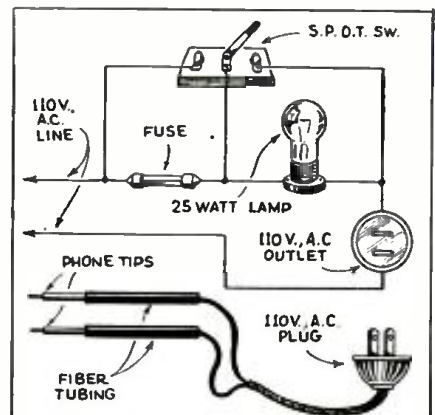
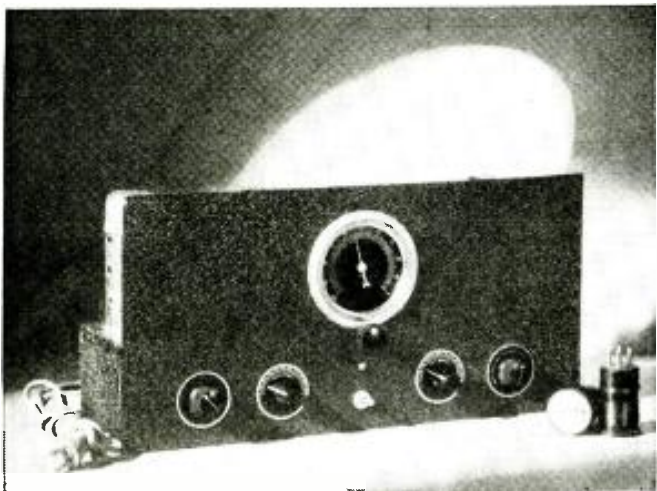

Fig. 4, above; square holes in metal.

Fig. 5, below; to prevent blown fuses.





BUILD THE 5-TUBE ALL-STAR

Here's the latest in all-wave receivers! A 5-tube, band-spread, 110 V., 60 cycle superheterodyne for home constructors, using standard parts which are available from all radio parts distributors. This easily built little receiver may be assembled "piece-meal" by the frugal experimenter. A fine set for the beginner—a laborer, after 1/2-hour's instruction built a perfect model!

SUCCESS on short waves demands a well-designed receiver. Superheterodynes have proved their superiority in reaching half way around the world for elusive and interesting short-wave programs. The design permits the home constructor to not only enjoy the most distant reception, but to obtain the thrill of actually building with his own hands a receiver capable of such performance. The new set is a happy combination of efficient design and simplified construction.

Analysis of the Circuit

The antenna coil is arranged for use with the doublet or plain type aerial and ground. Three binding posts are provided on the back of the chassis for the different antenna combinations. The first tube is a combination mixer and oscillator 6A7. A feature of this circuit is a local-distance switch that throws an extra bias voltage on the mixer tube for reception of local broadcast signals. This increased bias sharpens the tuning and prevents overloading the remaining tubes.

A double-tuned high-gain input I.F. transformer, pre-tuned to 370 kc., couples the plate circuit of the 6A7 to the grid circuit of the 6F7. This tube is a combination pentode and triode—in this circuit the pentode portion acts as the I.F. amplifier, its plate circuit containing the output I.F. transformer.

The appearance of the completely assembled receiver, ready for operation.

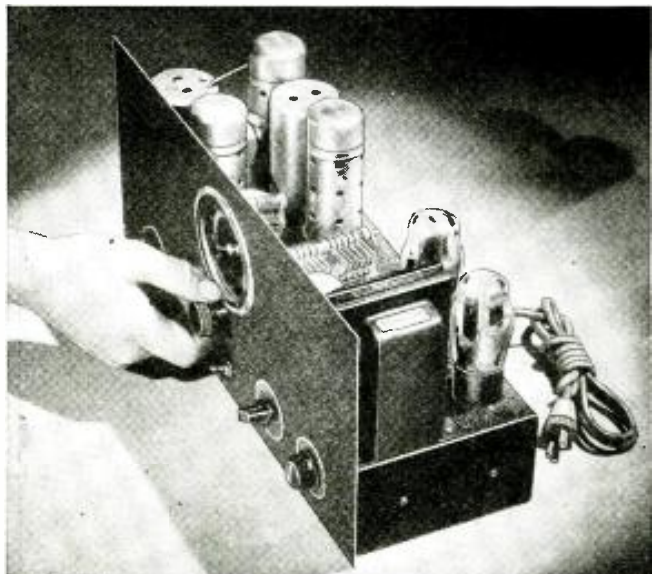

The triode portion is wired to a separate shielded transformer, BFO in the diagram, and serves as a beat-frequency oscillator controlled by a special switch on the front of the panel. The output I.F. transformer is of the double-tuned type particularly designed to match the plate circuit of the 6F7 to the control-grid circuit of the 77 tube, which is employed in the second-detector position.

Filtering R.F. "Transients"

A special feature of this circuit is the method of filtering R.F. transient currents out of the audio circuit by connecting the screen-grid of the 77 to the plate through a high resistance. The customary pair of 500 mmf. condensers and R.F. choke in the plate circuit further assure a clean audio signal reaching the grid of the 42 power tube. Resistance-capacity coupling employed between the 77 and the 42 is utilized for maximum fidelity in the audio amplification of the signals. The 42 power tube operates on full voltage and delivers 3 watts maximum signal to the dynamic reproducer. An 80 tube and standard type filter circuit make up the rectifier and "B" supply. To secure adequate voltage regulation, a 1000 ohm dynamic-speaker field serves as the second filter choke. To prevent reproduction of hum in the speaker due to the presence of the A.C. ripple in its field, a speaker is specified which contains a copper shield around the field coil. This acts as an inductive shunt for the A.C. component of the field current and prevents pick-up of the hum by the voice coil.

The Construction

The assembly of the set is particularly simple due to the small number of parts which are employed. The "foundation unit," consisting of a drilled metal chassis base and an etched and drilled panel, is supplied with complete plans for assembly and operation. All parts and mounting dimensions are clearly listed. Both schematic and pictorial wiring diagrams are included.

The first part of the assembly consists of mounting the wafer sockets on the chassis. Size 6-32 1/2-in. bolts with nuts and lock washers may be used for this purpose. The power transformer should be mounted next with size 8-32 1/2-in. bolts. Lock washers should be used on all parts fastened to the chassis to insure good electrical contact and permanent position. The filament and plate wiring which appears in the first pictorial layout (Part II) should be installed. Flexible tinned copper push-back wire may be used on all circuits. The next step in the assembly is the installation of the I.F. coils and the beat-frequency oscillator coil. All connections are kept as short and direct as possible. It is well to mount all the parts on the chassis before mounting the panel, as it is likely to be scratched in handling.



A SIMPLE "1-TUBE" ALL-WAVE ALL-ELECTRIC SET

Here is a beginner's set which has the appearance of a professional job—and it is just as simple to make as a bread-board job. While at first glance it may seem complicated, it is really simplicity itself. A special tube which is really two tubes in one makes it possible to make this one tube set all-electric.

W. GREEN*

WHILE many beginners like to layout all the parts to be used in set construction on a board, in plain sight, we feel there are just as many who want to begin with a real modern, "chassis-built" job. Actually, it is easier to build and operate an up-to-the-minute all-electric set using the latest tube, than to design and construct an old-timer. It's up to you!

Here it is. It uses the 12A7 tube, actually two tubes in one. Parts required are few and simple. Assembly and wiring need occupy no longer than one evening. And yet it is possible to tune in short-wave and broadcast stations (using earphones) from great distances.

There is nothing complicated about the construction of this set. While at first glance it might seem quite complicated, actually there is "nothing to it." Just build the instrument piece by piece, and watch how easily and quickly it goes together.

Just place all the components in position, as per the picture diagram, Fig. 1B, and the photograph, Fig. A. Then, after studying the schematic circuit, wire up the instrument in accordance with Fig. 1A. Only remember to use a hot iron (not red-hot), and resin-core solder, and make certain that all connections to be soldered are clean.

The only accessories needed are one type 12A7 tube (which combines in one envelope a pentode of the A.F. output type, and a half-wave rectifier), an aerial (almost any sort of aerial will suffice, but one built in accordance with the detailed information in the July and August, 1934, issues of RADIO-CRAFT will permit maximum efficiency to be secured on wavelengths below 200 meters), and a pair of earphones. The set will work perfectly without a cabinet, but a neat, stained cabinet keeps out dust and enhances the appearance.

To operate: plug in the coil covering the wave-band selected. For beginners we recommend strongly that the broadcast coil be used first, since tuning is much easier than for short waves. Connect aerial, phones and then plug into any house outlet (A.C. or D.C.). Turn up the right-hand knob slowly until a rushing noise is heard in the phones. This is the most sensitive point and makes a whale of a difference in the volume of signals. But it is best to back off a little to the left to clarify music and speech. Then tune

in your stations to your heart's content with the left-hand knob, while varying the right one slightly. The center knob tunes the antenna circuit. As you become familiar with the operation you will have no difficulty with it. Keep a careful record of just where each station comes in—it is necessary when you bring your friends around to show off.

Don't be too anxious to get Europe or Australia the first day. You'll get around to it after the first thrill wears off. In any event, provide yourself with a "short-wave log and call-book" obtainable on most newsstands, so that you will not be wasting valuable time trying to get stations that are not on the air, or which are not received well at the time of day you are listening.

List of Parts

- One Harrison duette chassis;
- One duette cabinet;
- One 7 prong socket, 12A7;
- One 4 prong socket;
- One electrolytic condenser, double-4 mf;
- One potentiometer with switch, 50,000 ohms;
- One dial drive;
- One dial scale;

(Continued on page 570)

Fig. 1—The picture and schematic circuits for the set.

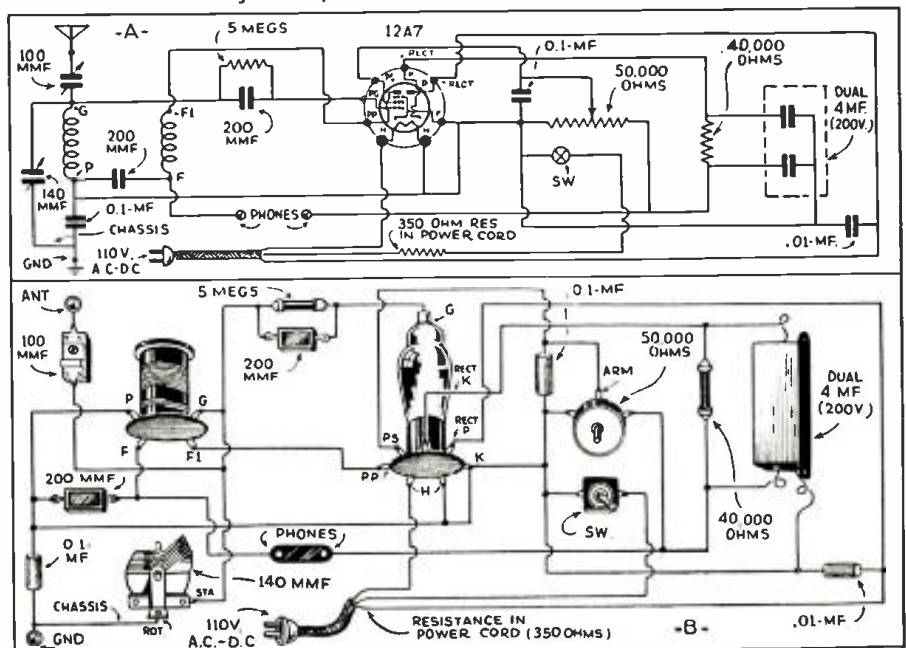

*Chief Eng.—Harrison Radio Co.

PUTTING "HIGH-FIDELITY" INTO OLD SETS

In this article, the author continues his discussion, of problems encountered in obtaining wide-frequency response in broadcast receivers, begun in the December issue.

WILHELM E. SCHRAGE

THERE is a great deal of discussion at present among amateurs and Service Men regarding high fidelity; with Service Men often getting inquiries relative to the reconstruction of radio receivers so as to obtain real high-fidelity performance. Before starting with the reconstruction of old sets it is important to know that in high-fidelity reproduction a great many more physical and musical factors are involved than appear at first glance. It is, for example, worthwhile to know that the acoustical "boundary-line" of the music instruments used today embraces the tremendous audio frequency range of from 25 to 15,000 cycles (see Fig. 1A)! In simple language this means that there is an audio range involved that is three times as large as the reproduction range of the average set used today! However, this is not sufficient reason to state that the new high-fidelity receivers now on the market, (with a reproduction range from 50 to 7,500 cycles only—the R. M. A. rating for "high-fidelity" reproduction, and a more convenient initial step in-

to this field by the manufacturers, who do not wish to use all their "ammunition" at one time), are really not high-fidelity sets.

What Constitutes High Fidelity?

Tests made in various laboratories throughout this country and abroad have shown that a larger reproduction range than 7,500 cycles is not necessary since only the musically trained radio listener can recognize the difference between reproduction comprising 7,500 or 15,000 cycles. In looking over the programs of the larger networks we find that in the case of broadcasting station on the air for 10 hours, frequencies above 7,500 cycles, appear less than 8 minutes of the broadcast time (or 1.5 per cent of the entire time).

As evidence of the desirable width of frequency range required for high-fidelity performance, the United States recently submitted to the International Radio Conference at Lisbon dates and facts which showed the quality of orchestral music, as judged by ten ex-

(Continued on page 554)

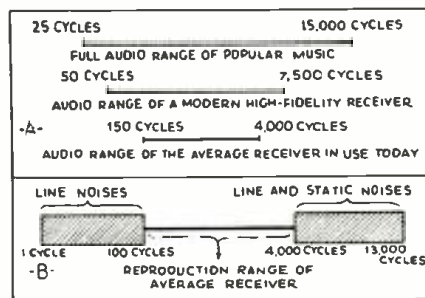

Fig. 1
The average range of sets and music.

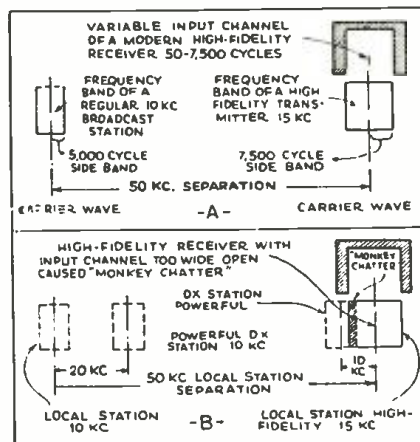

Fig. 2
Problems encountered in hi-fidelity sets.

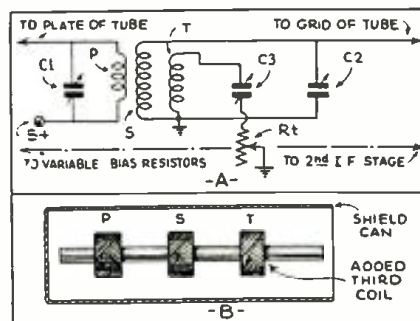

Fig. 3
Changing I.F. coils to broaden tuning.

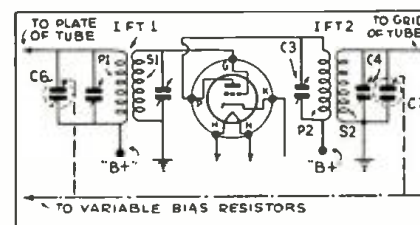
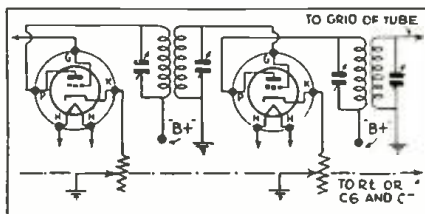
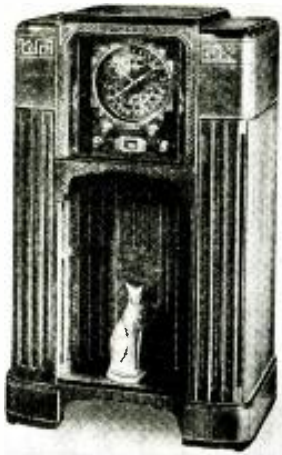

Fig. 4
Broadening tuning by detuning I.F. circuits.



THE LATEST RADIO EQUIPMENT



25-tube SUPER radio set. (653)



High-fidelity crystal mike. (654)

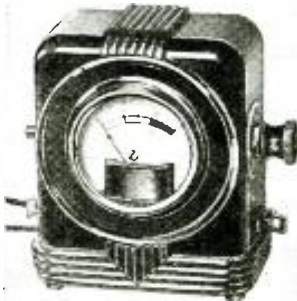

Regulator for 2 V. tubes. (655)



New distributor suppressor. (656)

Vest pocket tool kit. (657)



A 25 TUBE, 3 SPEAKER DELUXE RADIO SET (653)

WHILE comparatively few people will be able to own one of these superb instruments, everyone should be curious to know what it is and does. While we can't list all the features in these columns, a few outstanding ones may be mentioned.

The set uses a 6D6 tube as a shadow tuning meter to improve weak signals. A 79 acts as a relay for "Q" circuits. Eight (count 'em!) 45s in parallel push-pull furnish the final output. A.V.C. employs one 6D6 and one 85. Three 5Z3s act as rectifiers. The other 10 tubes merely fulfill the normal functions of any other set! Two speakers handle the low-frequency response, while a horn-type high-frequency dynamic takes care of the high end of the scale. "High fidelity" can be varied by the user. Unusual A.V.C. is found in the use of an extra tube for "disappearing delay" on weak signals. Tuning ratios are 18:1 and 99:1, allowing foreign broadcasts to be tuned in easily. Naturally the cabinets enclosing this radio behemoth are fitting and proper in superb craftsmanship. And the price? Oh, just about the same as a good low-priced new car!

HIGH-FIDELITY CRYSTAL MICROPHONE (654)

(The Turner Company)

HERE is an instrument which makes possible a high standard of transmission, either in public address or broadcast work. Although having an exceptionally flat frequency response, it sells at a very moderate price. The piezo crystal is mounted on a new resilient material which is impervious to heat and moisture. Since the unit carries its own field it requires no energizing circuit, which simplifies the microphone hookup.

VOLTAGE REGULATOR FOR 2 V. TUBES (655)

WHEN using ordinary rheostats for controlling voltage on "30 series" tubes, it is practically impossible to keep from occasionally giving them too much voltage. With this device, an accurate voltmeter (0-3 V.) can be snapped into circuit as often as desired and voltage corrected accordingly. Overall di-

Variable transmitting coil. (658)

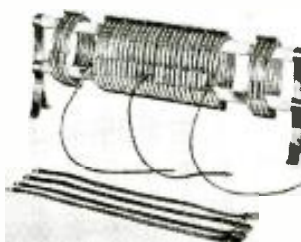

mensions: $4\frac{1}{2} \times 3\frac{1}{2} \times 1\frac{3}{4}$ ins. Bakelite case.

NEW DISTRIBUTOR SUPPRESSOR (656)

(Continental Carbon, Inc.)

A DISTRIBUTOR suppressor with several new and distinctive features has just been announced. It has a standard resistance of 10,000 ohms, which operates satisfactorily without loss of suppressor efficiency.

A spring insert, molded into the bakelite housing of the suppressor, fits $\frac{1}{8}$ -in. below the top of the distributor well, thus minimizing high tension leakage. The insert is easily adjusted with a pair of pliers to fit any hole and with any desired spring tension.

A convenient screw terminal for the cable provides a waterproof joint. In addition the rubber cap may also be fitted around the suppressor for waterproofing.

VERY HANDY TOOL KIT (657)

(Insuline Corp. of America)

THIS Service Men's neutralizing and aligning tool kit has been prepared to include every combination of convenient tools likely to be needed when adjusting all kinds of modern receivers. The kit consists of 12 distinct tools, telescoped to form only 4 units when assembled. The entire outfit, including a neat black case, fits in a vest pocket.

ALL-BAND TRANSMITTING INDUCTANCE (658)

(Thordarson Elec. Mfg. Co.)

NOW IT is possible for hams and commercial operators alike to cover all bands between 20 and 160 meters with a single inductance.

This inductance is a helically-wound coil of copper tubing, $4\frac{1}{2}$ ins. in diameter, divided into a number of 4-turn coil units. The inductance per turn is approximately one microhenry.

NEW PAPER CONDENSERS (659)

(Cornell-Dubilier Corp.)

A BRAND new line of condensers, suitable for use as a bypass or in filter circuits. There are 3 series. One series with cardboard containers is designed for a working voltage of 450 V.D.C., with capacities

High-volt paper condensers. (659)



from 2 to 8 mf. Another group, also in cardboard containers, has a working voltage of 600 V. D.C. with the same relative capacities. The third group in metal containers, also with a working voltage of 600 V. D.C., comes in capacities ranging from 4 to 18 mf. All are readily interchangeable with electrolytic condensers of corresponding capacities and are of approximately the same relative size and shape as electrolytics.

MELLOW CHIME ANNOUNCES CALLERS (660)

THEY'VE dressed up the old door bell. A single, carrying tone of real beauty takes the place of the former jangling gongs. A flat bar of metal vibrates upon impact with the felt-tipped core of a solenoid—the action is "single-stroke." Wiring is just the same as for the usual bell.

STEP-DOWN 220-110 V. TRANSFORMERS (661)

NOW available are two transformers, rated at 125 and 250 W. respectively, to furnish 110 V., 60 cycles, for radio operation in 220 V. districts. These models are designed especially for radio use, are small and compact, and are equipped with receptacle on the secondary and 9 ft. of cord on the primary. Transformers are available in sizes from 100 to 5,000 W., (the larger sizes for operating many sets at one time). Also made for 25 cycles at special prices.

TWO NEW HIGH-FIDELITY SPEAKERS (662)

TWO new speakers, large, sturdy, attractively finished, and offering something gratifying in tonal quality, are offered. Each is large enough for auditorium use and is recommended for program reproduction in schools, clubs, hotels and as an auxiliary speaker for midget sets. It is claimed that one of these speakers (A.C. or D.C. model) will give a midget the tone of a console. Frequency response is excellent from 50 to 6,000 cycles. Power handling capacity is rated between 10 W. and 25 W.

NEW 5-PURPOSE TESTER (663)

(Radio City Products Co.)

A COMPACT multi-purpose tester designed to do a thorough job on any receiver including auto radio sets. Any desired circuit or range is available merely by moving the selector switch to the etched position marks. A tapered compensator insures smooth zero adjustment on all ohmmeter ranges. It has 4 voltmeter ranges (0-5, 0-50, 0-250, and 0-750); 3 ohmmeter ranges (0-2,000, 0-1/5 megohm and 0-2 megs.); current ranges from 0-50 ma. and from 0-1500 microamperes.

A sensitive $3\frac{1}{4}$ -in. D'Arsonval moving-coil meter registers values within 2 per cent accuracy.

Name of manufacturer of any device will be sent on receipt of a self-addressed, stamped envelope. Kindly give (number) in description under picture.

LATEST MIDGET I.F.'S (664)

(Hammarlund Mfg. Co.)

EXCEPT for their tiny size, these transformers are claimed to be every bit as efficient as their larger brothers. They are of the tuned-grid, tuned-plate type, with lattice-wound coils, impregnated. Tuning condensers are mica compression type on isolantite—adjustable from top of can. Leads are R.M.A. color coded and tagged. Coil-secondaries are either standard or center-tapped. Built in 465 and 175 kc. styles. Total overall size of can is 3 1/2 x 1-7/16 ins. square.

CONVENIENT HAND-MICROPHONE (665)

(Universal Microphone Co., Ltd.)

A PARTICULARLY neat and light hand microphone for low-power P.A. systems: lunch rooms, hotel lobbies and the like—where the feedback condition is aggravated due to close proximity of speaker or from other causes. A handy switch cuts in and out of circuit with a flip of the thumb.

AN ACCURATE \$4 OUTPUT METER (666)

(RCA Victor Co., Inc.)

AN EXTREMELY compact little device capable of accurately measuring the output of any receiver has come to our attention. It is simplicity itself. A tapped-primary transformer provides for either high or low impedance input. Three binding posts allow for 1 1/2, 4 or 6 ohms. A neon tube and a potentiometer complete the outfit. Adjustment of the potentiometer until the tube lights is all the operation necessary. Scale on potentiometer gives reading. This device is sensitive and more durable than some other types of meters.

VIBRATOR CONDENSERS FOR AUTO RADIO SETS (667)

(Aerovox Corp.)

REPLACEMENT condensers for ruptured auto units. Made with 100 per cent all-linen paper, oil-impregnated, oil-filled, and sealed in soldered steel cans. They are built to stand up under the severe treatment accorded units of this type. Provided with mounting lug and pigtail lead.

TWO DESK-TYPE MICROPHONES (668)

DURABLE, sensitive double-button mikes for use with P.A. systems and for office call systems. One model has a non-insulated base, and is designed to feed either A.C. or D.C. amplifier. The other, insulated, will work a universal A.C.

"Mellow" door chime. (660)

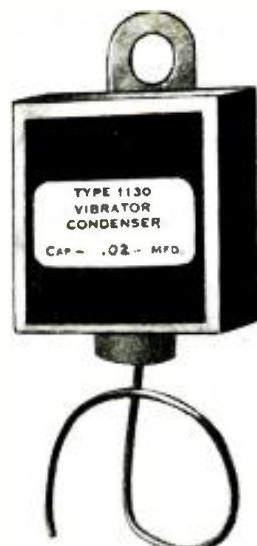
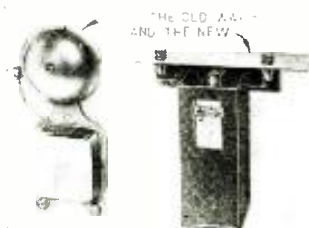

Auto-vibrator condensers. (667)

D.C. amplifier. Both are handsomely finished in black and chrome.

"WAVE-EQUALIZED" CONDENSER MICROPHONE (669)

(Shure Brothers Co.)

BY SOME careful engineering, the manufacturers of this instrument claim to have completely avoided "cavity-resonance" peak—an annoying characteristic of some microphones of this type. High-fidelity response is obtained in a rather unusual way—by deliberately avoiding a "straight-line response," and varying it to produce practically even tonal quality throughout the range (50-7,500 cycles). The standard bullet-type microphone and pre-amplifier form is used. The diaphragm, carefully stretched in a lathe-turned head, is entirely exposed to the incident sound wave. The units are carefully compensated for barometric changes. Performance comparison charts show remarkable fidelity to the full octave spectrum of various instruments and voice combinations. A quality job throughout.

RECORDING UNITS (670)

(Electric Laboratories Co., Inc.)

THREE new units selling at very reasonable prices. It is possible to incorporate them in an efficient recording-reproducing arrangement working through a good amplifier and reproducer, with excellent frequency response between 100 and 5,000 cycles. The recorder is designed to cut 96 lines per inch in aluminum records at either 78 or 33 1/3 r.p.m. Furnished in 15 ohms standard, and 200, 500 or 4,000 ohms special. Only one 3/4-in. hole is necessary for mounting. The pick-

To step-down 220 to 110 V. (661)



HIGH-FIDELITY CONDENSER "MIKE"

2-STAGE AMPLIFIER

New condenser microphone. (669)

up is correctly damped and balanced and carefully proportioned throughout. Furnished in any desired impedance. Cutting heads are supplied in five impedances, 15 to 5,000 ohms. Output, approximately 0.6-V.

A DE LUXE VELOCITY "MIKE" (671)

(Bruno Laboratories)

TO MEET the needs of broadcast and recording studios, and sound equipment company and public address apparatus users, there has been developed a "deluxe" model velocity microphone.

It affords a high degree of fidelity due to the exceptionally wide range of frequency response brought about by the materials used and the correctly-designed case in which it is enclosed.

The powerful cobalt magnets are used to produce a strong magnetic field in which is suspended a specially treated aluminum alloy ribbon. Cavity resonances have been entirely eliminated by the correct placement of the magnetic assembly. It is generally known that obstructions at the back of the ribbon will cause reverberations which tend to distort and emphasize some of the individual frequencies. A sound wave striking the ribbon will continue to travel without impediment and will not be reflected back by the inner portion of the horseshoe magnets as is design employed by many makers.

(Continued on page 571)

Desk-type 2-button "mike." (668)



High-fidelity reproducer. (662)



Multi-purpose tester. (663)

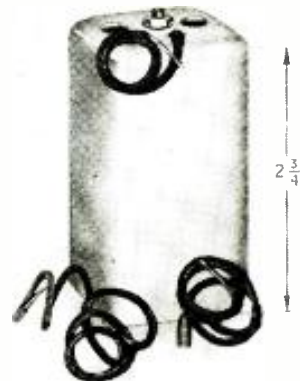

Tiny I.F.'s for midgets. (664)



Handy microphone set. (665)

Neon-tube output meter. (666)



THE ANALYSIS OF RADIO RECEIVER SYMPTOMS

OPERATING NOTES

WHAT THIS DEPARTMENT IS FOR

It is conducted especially for the professional Service Man. In it will be found the most unusual troubles encountered in radio service work, written in a practical manner, by Service Men for you.

Have you, as a professional man, encountered any unusual or interesting Service Kinks that may help your fellow workers? If so, let us have them. They will be paid for, upon publication, at regular space rates.

ATWATER KENT 84—EARLY MODEL

SET "dead" on receipt at the shop (See Fig. 1, to which all text is referred.) Cause, three open chokes, one of which, the antenna choke (130 ohms), will not necessarily cause a "dead" set. The 24A first-detector plate choke (66 ohms in value) was open, due to corrosion at the terminals; repaired, it was O.K., and this circuit then was O.K. The plate coupling and I.F. selecting choke (also 66 ohms) in the grid lead of the 24A I.F. tube was open internally (as was the antenna choke) and was replaced. Antenna choke was replaced. The normally 40,000-ohm bias resistor in the oscillator (27) circuit measured 60,000 ohms, and was replaced. The set then apparently in good order, was left playing, after the usual resistor, coil, condenser, and tube tests had been made and the condenser contacts cleaned plus a regular alignment. The set was fine for some hours, then became noisy, signals faded, and the set gave all the symp-

toms of an intermittent open somewhere. The I.F. transformer, suspected, turned out to be the source of trouble with an intermittently opening primary of about 78 ohms normally. Replacement and realignment gave a perfectly operating job and satisfaction.

GULBRANSEN "CHAMPION JUNIOR"

SET received at the shop "dead." Trouble was found to be due to double open, by corrosion, of the first A.F. transformer primary leads within the case or paper sheath. Remove transformer from set, carefully take off outer layers of paper and tape and the breaks can usually be readily located. After cleaning a fresh section of wire and removing all traces of green corrosion from the larger leads carefully solder in place again, and retape and insulate leads at points of attachment. The job is then as good as new. (This must be done if customer does not wish to pay for a new transformer or if it is not desired to use resistance or impedance coupling.)

Operation restored, set was sluggish, lacked clarity and "pep." Cause, a 50,000-ohm resistor had been put in by someone instead of a 4,000-ohm job, as in Fig. 2. The supposed 20,000-ohm job measured 40,000 ohms, and the other two also were way off value. By replacing all four mentioned resistors, cleaning all contacts and giving the set an accurate alignment by oscillator and output meter, after all bypass and filter condensers were found O.K. a fine set resulted.

JOHN MUEHLKE

TUBE BURN-OUTS IN 32-V. FARM SETS

FOR some time I have been troubled with tube burn-outs in a 32-V..

DEFECTIVE TUBES—

Are not to be considered as the subject for an Operating Note. It is assumed that all Service Men test tubes when making a service call. Their experiences on the subject of testing tubes, unless most unusual, are not of sufficient interest to other Service Men. Operating Notes should be confined to those faults which are characteristic of, and repeatedly occur in connection with a particular model of radio receiver.

farm electric sets. I could match the tubes for filament resistance and also current but still in about two weeks out would go a tube and it was usually a new one at that. I checked the set again for a short but found none. The tubes used are of the auto-radio type, 6.3-V. .3-A., with the heaters wired in series.

In testing these tubes for heater resistance I found that they tested about 3 ohms when cold. Now that would let 2 A. flow at 6 V., which would soon destroy a .3-A. filament, but as the tube warms up the resistance increases rapidly to 21 ohms. Next I timed the tubes to see how long it would take from the time the current was turned on, for cathode emission to start. This varied from about 7 to 15 seconds, the older tubes taking the longer time.

In these sets, if one tube warms up in 7 seconds and the others take 15 seconds this would throw a very high voltage across the quick-heater tube

(Continued on page 572)

Fig. 1
An Atwater Kent 84 (early model) goes "dead." Three R.F. chokes were the trouble-makers.

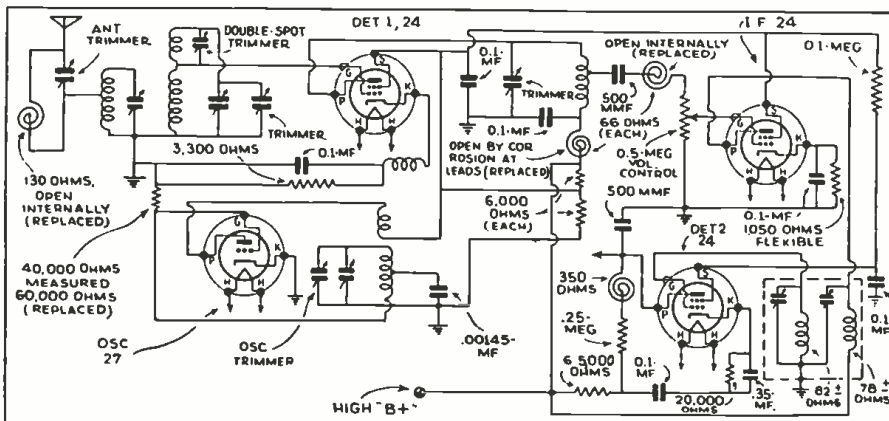
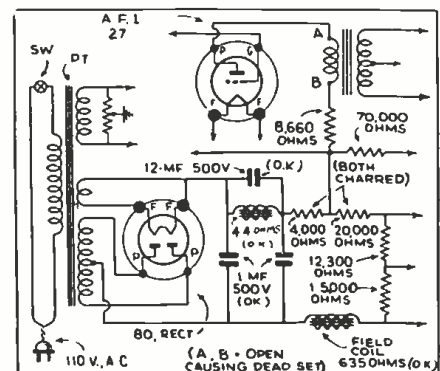

Fig. 2
Gulbransen "Champion Junior." Another "dead" set—due to open A.F. transformer. Lack of "pep" was traced to off-value resistors.



HOW TO MAKE A SENSITIVE INERTIA-TYPE RELAY FOR RADIODYNAMICS

F. D. ANDREWS*

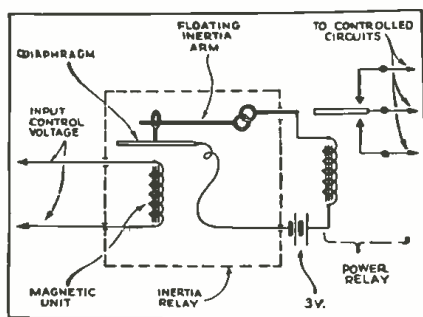
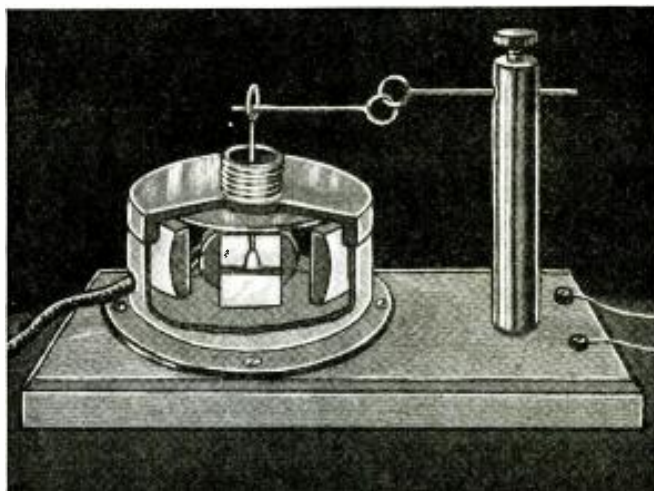

Fig. 1
The details of the inertia relay, connected to a secondary power relay.

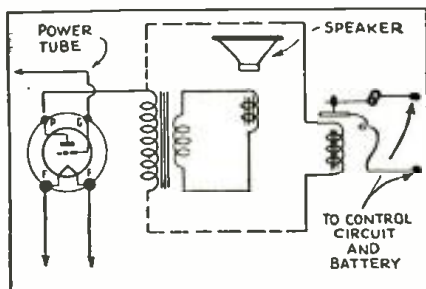

Fig. 2
The way in which the relay would be connected to a radio set or amplifier.

MANY experimenters, when working with "radio controlled" systems have found themselves confronted with the problem of obtaining sensitive relays capable of being actuated by the very feeble currents available from their radio receiving sets.

After several months of work on remotely controlled devices, the writer was able to assemble, from "junk" parts about the shop, a relay which was by far the most sensitive, most dependable and least expensive for this type of work. The description following should enable anyone to construct such an instrument without difficulty.

The Constructional Details

An old unit from a magnetic type speaker is obtained. The diaphragm actuating link is clipped off quite close

*Eng.: Andrews & Perillo.

to the unit housing and at this point is soldered a ring of brass or nickel wire about $\frac{1}{8}$ -in. in diameter. The exact size of this ring is not at all critical. The unit is now mounted on a baseboard so that the movement of the stem and ring is in a vertical plane.

The floating contact is prepared from a piece of copper wire of about No. 10 gauge, $\frac{1}{2}$ -in. in length. To one end of this piece of wire, an ordinary pin is soldered while to the other end is soldered a ring about $\frac{1}{8}$ - to $\frac{1}{4}$ -in. in diameter.

The support design is clearly shown in the drawing and needs no further description here than that the adjustable arm is equipped with another ring of about the same dimensions as the one described above and this ring is linked with the one on the "floating contact."

The device is assembled as shown in the illustrations. The pin of the "floating contact" resting in the ring is affixed to the diaphragm link of the speaker unit, so that it is free to move up and down without hindrance.

One contact of the circuit to be controlled is made to the support of the floating contact and the other to the stem of the speaker unit. This latter connection can usually be made to the body of the unit itself as usually the reed is grounded. Input connections to the device are, of course, made in the same manner in which speakers are usually connected; that is, to the magnet coil.

How It Works

It is plain to be seen that this relay is of the closed-circuit type—the circuit to the controlled device is closed when the reed of the speaker unit is at rest. Any audible vibration imposed upon this unit will cause the reed to vibrate in sympathy but due to the weight and consequent inertia of the relatively heavy "floating contact" it is unable to follow these vibrations. This establishes a very high resistance at the point of contact of the "floating contact" and the small ring mounted on the speaker reed and the controlled circuit is virtually opened for the duration of the vibration.

INERTIA-TYPE RELAY

One of the most interesting side lines for the radio beginner and experimenter to enter is that of "radiodynamics"—or the control of every imaginable object, from a distance.

An interesting example of such control appeared in the July, 1934, issue of RADIO-CRAFT, in the article, "A Radio-Controlled Boat"; see also, "Introducing Our Mr. Radio Robot" (July, 1931); and Hugo Gernsback's editorial, "Radio Telemechanics" (Sept. 1934).

In most applications of radiodynamics, sensitive relays are required to perform the varied and intricate tasks needed for complete control of the object. These relays are ordinarily quite expensive and it is with pleasure that we find such a simple and yet reliable unit as that described here by Mr. Andrews—who has made numerous radio robots and other intricate displays.

By means of this relay, devices can be operated directly from the output of a radio set, and "radio" control by means of a small oscillator and simple receiver is quite within the sensitivity range of the relay.

It has been found desirable to limit the current flow across the contacts of this relay to about 0.05 A., as heavy currents have a tendency to arc and cause considerable annoyance. If necessary to control heavier currents a suitable relay can be very easily improvised and connected as shown in Fig. 1, with a suitable battery to actuate the power relay.

If a fair amount of care is exercised in the construction of this device it will be found to perform in a highly satisfactory manner. It can be used in connection with either pulsating D.C. or with A.C. on any current of sufficient intensity to actuate a magnetic speaker. The output of A.C. sets should be as nearly hum-free as possible for best results.

The many uses for this super-sensitive relay are numerous and would occupy more space than it is possible to devote at this time. In a future issue some special applications will be given.



A SIMPLE ALL-WAVE OSCILLATOR

The Service Man and set constructor who works with all-wave receivers has need for an all-wave oscillator which is accurate within practical limits and which covers the short waves as well as the broadcast band and intermediate frequencies without excessive recourse to harmonics. Here is a fine one.

E. M. SHIEPE*

THE popularization of all-wave receivers has created the necessity for a simple effective oscillator covering not only the broadcast band and intermediate frequencies, but also the short waves, for servicing and aligning work.

The unit shown here has coils covering three fundamental wave bands—3800 to 1320 kc.; 1500 to 540 kc.; and 380 to 132 kc. These fundamental frequencies can be supplemented, of course, by the stronger harmonics to cover the frequencies between bands and the higher frequencies above the 3800 extremity.

The unit operates from the 115 V. A. C. line, obtaining not only the filament and plate currents but also the modulation frequency from this source. It uses a single type 37 tube with a 350 ohm resistor in series with the filament (Continued on page 567)

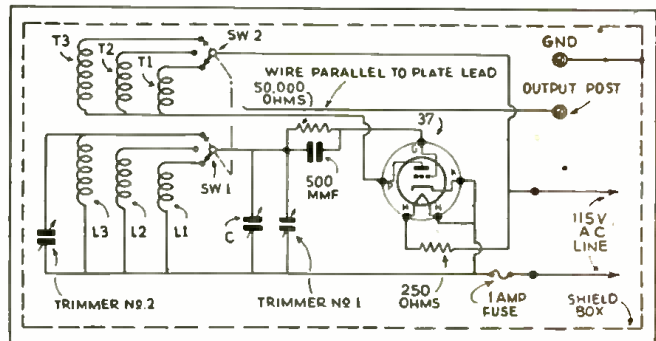

The circuit of the simple all-wave oscillator.

*Delta Radio Co.

A "3-in-2" SHORT-WAVE SET

This two tube short-wave set gives the results of a 3-tuber—it's easy to build.

A. G. HELLER*

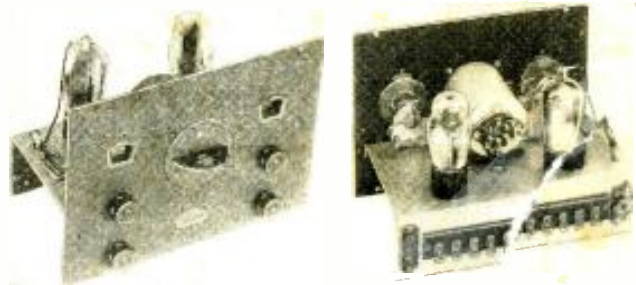

AN UNUSUAL feature of this two tube kit set is the use of plug-in coils from the front panel. No longer is it necessary to remove the chassis from its cabinet or lift the lid to change from one wave band to

another. The coils plug into a special shield can which thoroughly isolates the coil from the tube circuits and assures the user the best possible results. All the coils have specially designed handles which enable one to remove coils easily from the front panel. The

chassis and front panel are of metal and have a baked crackle finish.

Band spread control is incorporated in this circuit. This permits mechanical separation of stations which are spread over the entire dial. This principle improves the "apparent" selectivity of the receiver. In operation, the main tuning dial is set to the frequency desired to hear and the wavelength you desire is then indicated on the band-spread dial which distributes them over approximately 100 divisions of the dial.

A new circuit arrangement for regeneration control is incorporated in this receiver. Two tubes are used—one type 32 as a regenerative detector and one 19 as a dual triode tube as a two stage amplifier—giving the equivalent of a three tube set.

The construction of the set is not at all difficult. (Continued on page 569)

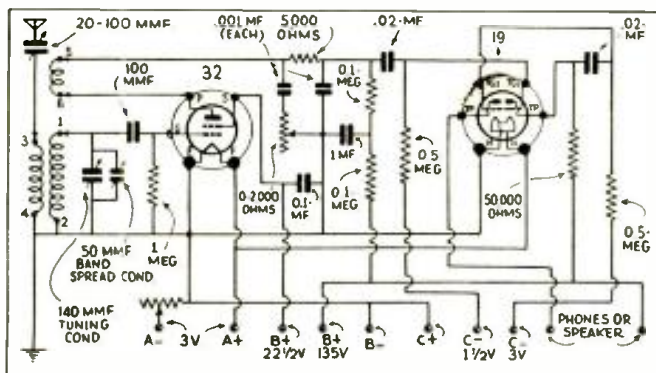

The wiring diagram of the "3-in-2" short-wave receiver showing the band-spread arrangement and unusual regeneration control.



ADDING A "TWEETER" FOR HIGH-FIDELITY

A high-frequency reproducer designed to boost dynamic reproducer response to 8,000 cycles (commercial "high-fidelity").

TODAY the demand for faithful and accurate reproduction of sound is concerning more and more people. The average dynamic speaker is not capable of sufficient frequency response to faithfully reproduce tones at the extremes of the audio spectrum, particularly in the higher registers. This new "tweeter" was made to complement a standard dynamic reproducer having a faithful response curve in the lower register. The "tweeter" is a small high-frequency crystal type reproducer. It is designed especially to flatten out the response curve where the dynamic speaker begins to fall off and to carry high-fidelity reproduction up (Continued on page 570)

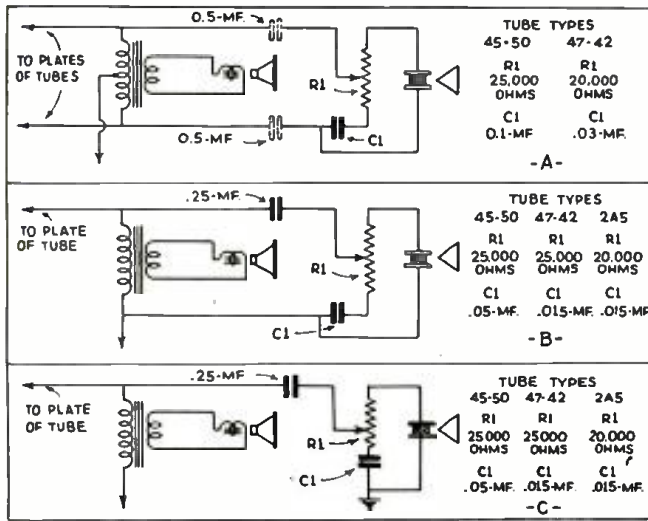

Illustrations, courtesy The Brush Development Co.

Fig. 1, left. Showing three ways of obtaining volume or tone control.

Fig. 2, right. Effect of adding "tweeter" to good dynamic speaker.

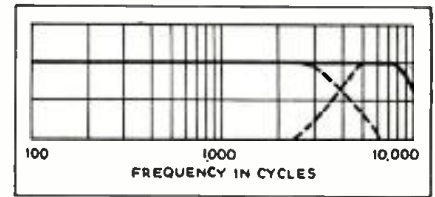

A MAN-BACK PUBLIC ADDRESS SYSTEM

The 1935 version of "the Sandwich Man" P.A. System

J. M. Kuhlik and Paul Komroff*

FEELING that there was a real need for a satisfactory method of advertising local businesses, this portable P.A. system was evolved. Realizing that certain rural territories where P.A. systems are particularly effective are not equipped to supply the necessary power for the average outfit, this entire system was designed to be carried by one man while canvassing a territory. The set is entirely self-contained. The unit in front carries a small spring-driven turntable motor designed to carry 3 records and a pickup. This unit also contains the amplifier with all controls necessary for operation. The rear unit carries the power supply consisting of portable "A" and "B" batteries as well as the

permanent magnet type dynamic speaker. A cord and socket arrangement connects the 2 units so that they may be disconnected and more readily transported. (Continued on page 559)

*Miles Reproducer Co., Inc.

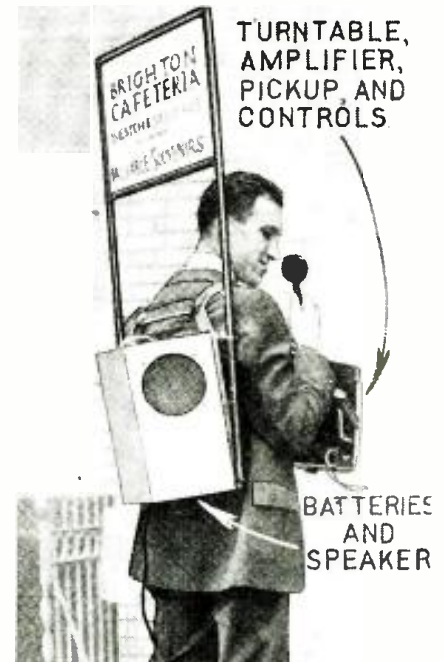

Right, the "one-man broadcasting station" in action!

Fig. 1, left, Schematic circuit employed in this novel P.A. system.

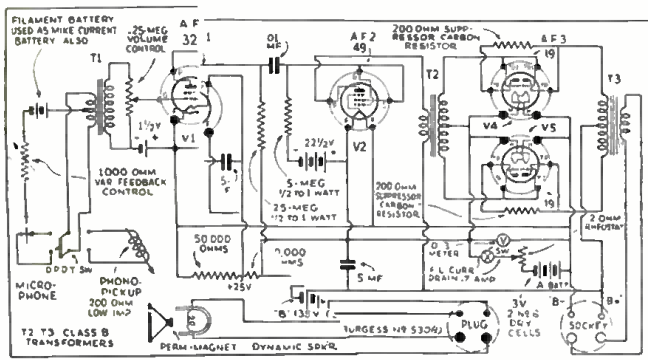

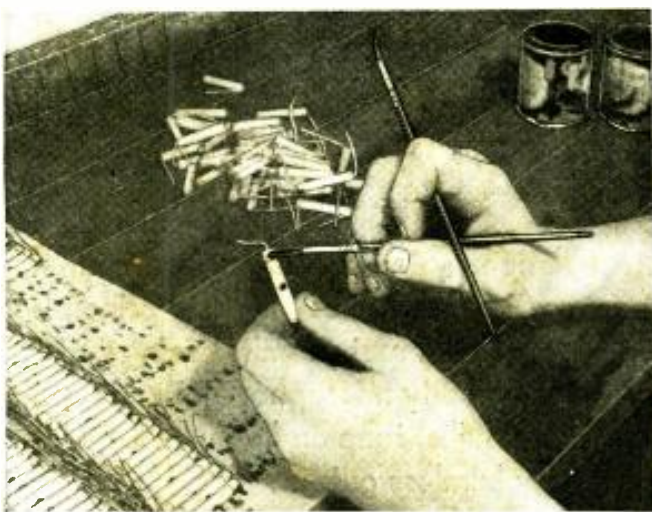

HOW RESISTORS ARE MADE

The radio beginner has no doubt wondered how resistors are made. This interesting article tells how the different types are manufactured, including a new method.

RALPH SAYRES

RESISTORS are now made by an entirely new process, by a well-known manufacturer, developed over the past six years as a result of intensive study of the different classes of resistors to eliminate the drawbacks of the general methods heretofore used.

A study of resistors shows that they fall into three classes, namely: wire-wound type, carbon-coated or film type, and carbon-composition molded type.

The first class is wire wound, and from a cost standpoint can be disregarded.

The second class is the so-called carbon-coated type, in which a thin film of carbon is placed on a glass or porcelain rod or tube. In some cases this is spiralled to vary the resistance. Briefly, this type has generally been discarded to-

day, and spiralled units are not being made in important quantities now. The film of carbon is very thin, and therefore, very fragile and unsafe. Mechanically such a structure is undesirable. Injuries easily occur; adhesion of the film to the supporting surface is difficult to control; contact is fragile; and transfer of heat energy depends on mechanical limitations of the whole assembly. The current-carrying capacity must necessarily be a function of the area or cross section and when the resistance is increased solely by cutting down the thickness of the film (already very thin), naturally the current-carrying capacity is impaired, and the current density increases tremendously. This gives rise to overheating, localized stresses and leads to ultimate failure and bad characteristics.

The third class is the so-called carbon stick or composition type. It consists of a mixture of a very small percentage of conducting material (carbon) and an insulating material
(Continued on page 568)

A PRE-AMPLIFIER FOR THE SHORT-WAVE RECEIVER

The operation of short-wave receivers can be materially improved by the addition of a separate amplifier which increases not only the volume, but also the selectivity of the set.

H. B. RUSS

MANY radio fans who have been bitten by the "short-wave bug" find after a time that they have exhausted the possibilities of foreign reception with their sets, or find that they cannot separate stations in certain of the crowded sections, such as the 49 meter band or some of the amateur phone bands.

Many of these fans hesitate about making or buying a larger short-wave or all-wave set because of the expense involved as well as the doubt which naturally arises as to whether they could get more stations or better selectivity with a new set.

These enthusiasts can surmount their difficulties by the addition of a pre-amplifier to their present sets.

Pre-Amplification

The word "pre-amplification" is almost self-explanatory. Pre-amplification is that process whereby a feeble radio frequency current (picked up via the

antenna) is increased in magnitude by virtue of the associated circuits and tubes in the pre-amplifier. Thus by pre-amplification we have at once accomplished several important and desirable results:

1. Very substantial increase in signal
2. Consequent increase in sensitivity.

(Continued on page 561)



The pre-amplifier in its neat crackle-finished box.

The circuit of the pre-amplifier is shown to the right with the values of all resistors and condensers marked. The coils cover the bands between 14 and 200 meters.

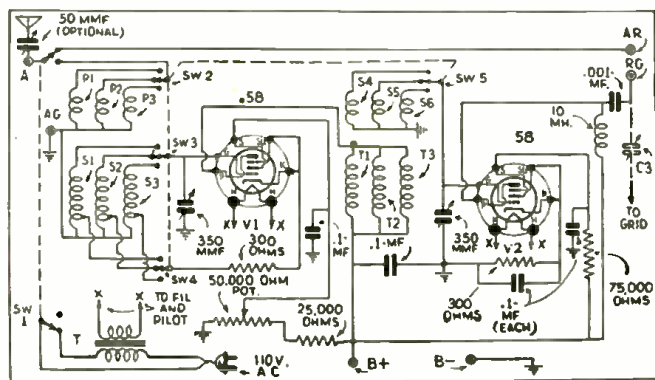

OFFICIAL RADIO SERVICE MEN'S ASSOCIATION, INC.

MEMBERS' FORUM

This department is devoted to members and those interested in the Official Radio Service Men's Association. It is the medium for exchanging ideas, kinks, gossip and notes of interest to those who comprise the membership.

A COMMENT ON STICKING VIBRATORS

RADIO-CRAFT, ORSMA Dept.:

I have read the comment which you published on vibrators sticking in automobile radio sets. I work for the Philco Radio and Television Co., and have worked on vibrators.

It is advisable to change all defective vibrators as it is hard to make a satisfactory job repairing them in the shop. I have taken many vibrators apart that Service Men have tried to repair but without success. The new type vibrators should work longer than the older ones, but they don't last forever and should be a regular source of income to the dealer and Service Man.

RICHARD J. HAMME

This is one of many letters received in response to the question which appeared in a letter on this page, several months ago. It is almost a universal opinion among the members, judging from the letters received, that a vibrator type rectifier should be replaced whenever trouble arises, however long the unit has been in service.

As pointed out in Mr. Hamme's letter this mortality in vibrators should prove to be a constant source of income to the Service Man. But it should also be remembered that it will also be a source of complaints and profitless repeat calls.

Only the best of such units should be used for replacement purposes for this reason.

OHM'S LAW WITH ONE METER

RADIO-CRAFT, ORSMA Dept.:

There are many experimenters who, in their daily work find the pressing need for the determination of voltage, current and resistance. Often, the particular measurement they seek is not within the range of their instruments, or what is just as likely, two meters may not be at hand.

Here is a simple and effective method whereby only a voltmeter or an ammeter is necessary to determine the remaining current and resistance or voltage and resistance respectively.

All that is necessary is to obtain a known resistance. This may be a new electric light bulb, the resistance of which is calculated from the formula: $R = \frac{E^2}{W}$, in which R equals the resist-

ance, E equals the voltage and W is the watts rating stamped on the bulb. A piece of high resistance wire, an electric iron, electric stove or toaster, etc., may be used in lieu of the lamp. If the wattage of these things is known, the above formula may be used to determine resistance. But if the wattage is unknown, it is necessary to use both

a voltmeter and an ammeter to predetermine the device's resistance in accordance with the formula: $R = \frac{E}{I}$

where I is the amperage, and E and R are the same as for the first formula.

When we have the known resistance (and in order to obtain a wider range of measurements, it is suggested that several different resistance values be obtained) the procedure to get a reading is as follows:

If only a voltmeter is used, set up a circuit as in Fig. 1A. This is a series circuit where "X" is the object of unknown resistance and "k" is the known resistance which has been obtained. Take a reading with the voltmeter across "X" by putting it in parallel. Record this reading. Then take a reading across "k" in a like manner and record it. Substitute these readings in the formula: $R_x = \frac{E_x \times R_k}{E_k}$ where R_x

is the unknown resistance, E_x the voltage reading across "x," R_k the known resistance and E_k the voltage reading across "k." For example if the voltage across "x" is 20, the value of "k" is 30, and R_k equals 200, we have $R_x = \frac{20 \times 200}{30}$ which equals 133.33

ohms. The current in amperes, being

(Continued on page 558)

Fig. 1

Two ways of using a single meter to indicate voltage, current and resistance.

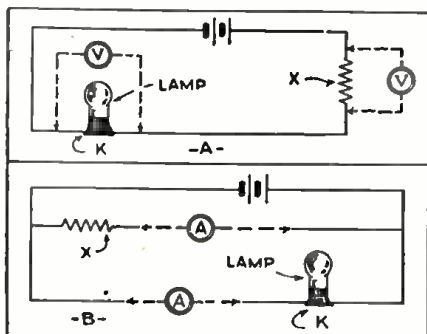

Fig. 2

Here's a simple way to check the operation of A.F. amplifiers of any type.

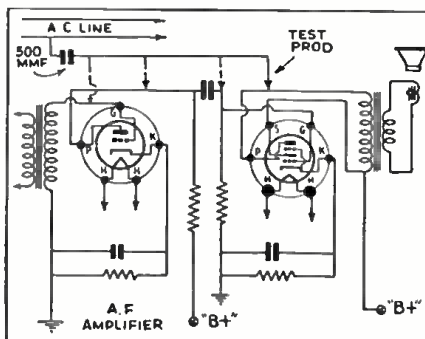
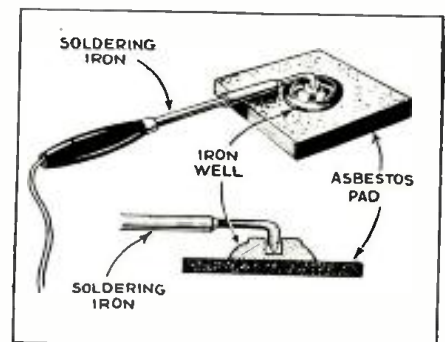

Fig. 3

This soldering iron will not become corroded as quickly as usual.



RADIO-CRAFT'S INFORMATION BUREAU

SIMPLE TEXT-BOOKS FOR THE RADIO BEGINNER

(308) Mr. Charles G. Post, Duluth, Minn.

(Q.) Can you refer me to a few books on radio, written in a simple, non-technical way, preferably with some elementary hookups and constructional material? I am a beginner and get confused with the books available.

(A.) This list should be just the thing:

- Modern Vacuum Tubes
- Radio Questions and Answers
- Modern Radio Hookups
- Radio Kinks and Wrinkles
- The Superheterodyne Book

All of the above may be obtained at 50 cents a copy from Continental Publications, Inc., 99 Hudson Street, New York, N.Y.

USING NEON TUBE AS OUTPUT INDICATOR

(309) Mr. John R. Davis, Bangor, Me.

(Q.) Can you furnish a diagram of a simple device for comparing output powers of different sets?

(A.) The circuit below is simple, but the finished instrument is a wonder (see photo on the Latest Radio Equipment page). By connecting your set voice-coil to any two of the three posts, you are enabled to take care of any set impedance. Volume of set should be kept low when making test to prevent A.V.C. action. In operation, you retard the indicator's pot. until a very dull glow occurs in the lamp. Proceed with the receiver adjustment, noting that increased neon lamp brilliancy means better tuning condition of the receiver. By slowly backing down the pot, (counter clockwise) until lamp no longer glows, the set is functioning at its best output.

KADETTE CIRCUIT

(310) Mr. Isaac Bramin, Denver, Colo.

(Q.) Please furnish circuit diagram of International Radio Corporation's "Kadette Jewel."

(A.) The diagram appears in Fig. Q. 311.

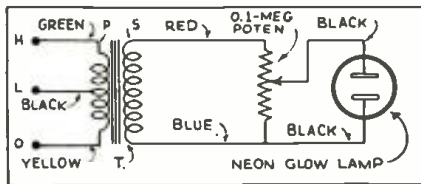
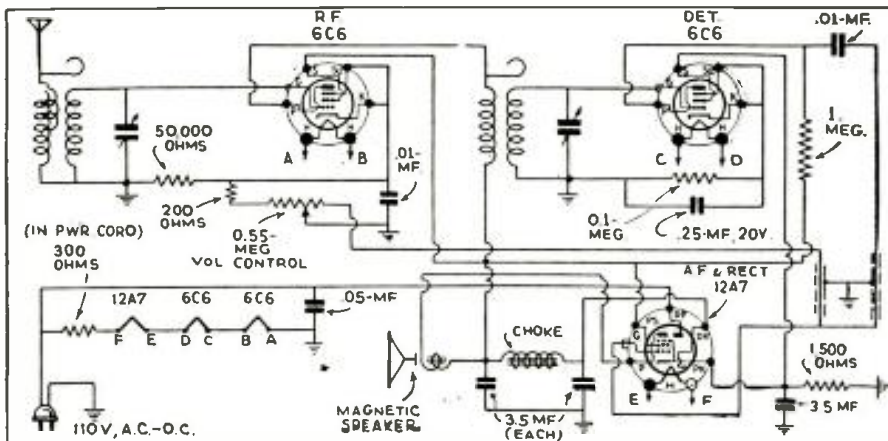

Fig. Q.309, above
Effective neon output indicators.

Fig. Q.310, below
Schematic diagram of "Kadette Jewel."



"SERVICE MAN'S ALL-WAVE OSCILLATOR"

(Correction)

(311) Mr. G. A. Becker, 5341 Ewing Ave. S., Minneapolis, Minn.

(Q.) Referring to the article in the January issue of RADIO CRAFT covering an all-wave oscillator, wasn't there something left out of the schematic diagram? Where does the tuning condenser come in?

(A.) We referred your inquiry to the F. W. Sickles Company who reply as follows: "The condenser goes from the arm of the switch on the grid side, to ground or the common side of the circuit. We also wish to advise that the range is from 27 mc. to 110 kc."

A corrected diagram appears in Fig. Q. 311.

"RAW MATERIAL" FOR TUBES

(312) Mr. Jacob Pierkopf, Warren, Ohio.

(Q.1) What materials are used in modern radio tubes?

(A.1) For your information, and to enlighten many experienced as well as beginning radio hams, there are as many as sixty-two different materials and nine gases used in the manufacture of tubes produced by a leading manufacturer. Among the rarer materials are found: platinum, iridium, barium, silica, strontium, cobalt oxide, thorium nitrate, titanium, malachite, misch metal,—yes, and even volcanic lava! These rare ones are found in intimate association, in the tube, with such lowly things as woodfiber, tin, glycerine and common petroleum. Thus you may see that the little glass bottles in your set deserve to be treated with rare respect, instead of the snapping of fingers (and worse) sometimes abusing them.

(Q.2) Will you kindly explain what is meant by coated filament tubes, and what is the difference between oxide and thorium coating?

(A.2) This subject was covered thoroughly in the August 1934 issue of RADIO CRAFT. Briefly: Plain tungsten (used in early filaments) liberates electrons to the plate with difficulty due to the high affinity tungsten electrons have for that metal. Oxide-coated filaments are of a metal alloy, plus a uniform coating of certain

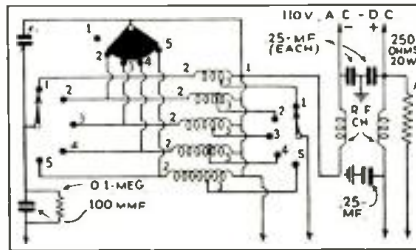

Fig. Q.311, above
Correction of oscillator circuit.

SPECIAL NOTICE

Those questions which are found to represent the greatest general interest will be published here, to the extent that space permits. (At least 5 weeks must elapse between the receipt of a question and the appearance of its answer here.) Mark such inquiries, "For Publication."

Replies, magazines, etc., cannot be sent C.O.D. Back issues of RADIO-CRAFT prior to December, 1932, are available at 50c per copy; except the following issues: 7/29, 2, 3, 4, 6, 7, 9 and 11/30; 5, 8 and 9/31; and 10/32, which are out of print. Succeeding issues are still available at the regular price of 25c per copy.

Inquiries to be answered by mail MUST be accompanied by 25c (stamps) for each separate question; answers are subject to subsequent publication if considered of exceptional interest.

Furnish sufficient information (in reference to magazine articles, be sure to mention issue, page, title, author and figure numbers), and draw a careful diagram (on separate paper) when needed to explain your meaning; use only one side of the paper. List each question. Be SURE to sign your name AND address.

Enclose only a STAMPED and self-addressed envelope for names and addresses of manufacturers; or, in connection with correspondence concerning corrections to articles, as this information is gratis.

Individual designs can be furnished at an additional service charge. The fee may be secured by addressing the inquiry to the SPECIAL SERVICE department, and furnishing COMPLETE specifications of desired information and available data.

oxides. Oxides liberate electrons freely at relatively low temperatures, in greater abundance than plain wire can do. Thorium isn't really a coating. It permeates the filament, but oozes to the surface at operating temperature. Practically all modern tubes have oxide-coated filaments or cathodes.

CURRENT-CARRYING CAPACITY OF WIRE

(313) Mr. L. L. Sander, Los Angeles, Calif.

(Q.) I should be glad if you would tell me where a chart showing current-carrying capacity of wires of various gauges can be obtained.

(A.) Since a wire will pass current until it fuses, we print herewith an interesting chart (courtesy of General Electric Supply Company) showing current necessary to fuse wires of different gauges and materials. Note that a No. 40 copper wire will actually take over 1.5 amps. without fusing!

Current Required to Fuse Wires, Copper, German Silver, and Iron

B. & S. Gauge	Copper Amperes	German Silver Amperes	Iron Amperes
10	333.0	159.0	101.0
11	284.0	146.0	86.0
12	235.0	120.7	71.2
13	200.0	102.6	63.0
14	166.0	85.2	50.2
15	139.0	71.2	42.1
16	117.0	60.0	35.5
17	99.0	50.4	32.6
18	82.8	43.5	27.1
19	66.7	33.2	20.2
20	58.3	29.9	17.7
21	49.3	25.3	14.9
22	41.2	21.1	12.5
23	34.5	17.7	10.9
24	28.9	14.8	8.76
25	24.6	12.6	7.46
26	20.6	10.6	6.22
27	17.7	9.1	5.36
28	14.7	7.5	4.15
29	12.5	6.11	3.79
30	10.25	5.26	3.11
31	8.75	4.49	2.65
32	7.26	3.73	2.2
33	6.19	3.13	1.84
34	5.12	2.64	1.55
35	4.37	2.24	1.33
36	3.62	1.86	1.09
37	3.08	1.53	.93
38	2.55	1.31	.77
39	2.20	1.13	.67
40	1.86	.95	.56

THE SIMPLEST SET

(314) Mr. L. A. Scott, Port Jervis, N.Y.
 (Q.) What is the simplest receiving set possible to make which will work?
 (A.) The simplest set which will produce audible tones consists of only a crystal detector and an earphone. Circuit "A" Fig. Q. 314C will work, but "B" is better. This hookup will actually receive strong signals as far as 50 miles away. However, it has no means of tuning one station from another, and would result in a hodge-podge of noise in a city such as New York. Adding a simple tuning coil, as shown in "C" allows better control although still there would be interference from near-by stations. There is a little pocket set on the market using a hookup like this. The tuning coil is wound on a flat piece of cardboard, and the whole set is only 4 ins. square and less than an inch thick. It gives fine results if you are close enough to a broadcasting station. A photo of this set is shown in Fig. Q. 314 A, and a cutaway sketch in Fig. Q. 314B.

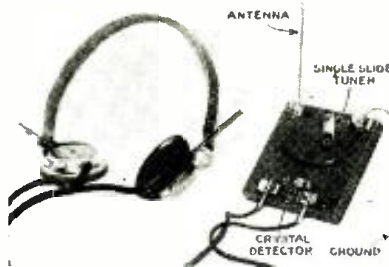

Fig. Q.314A, above
 The simplest tuned crystal set.

"AMPERITE PRE-AMPLIFIER" (Correction)

(315) Mr. Ross Bateman, Toledo, Oreg.
 (Q.) Was the circuit diagram of the A.C. pre-amplifier on page 338 of the December 1934 issue correct? Also please give values of all resistors and condensers.
 (A.) Several errors crept into that diagram. We are printing a corrected circuit in Fig. Q.314. Thank you for catching this!

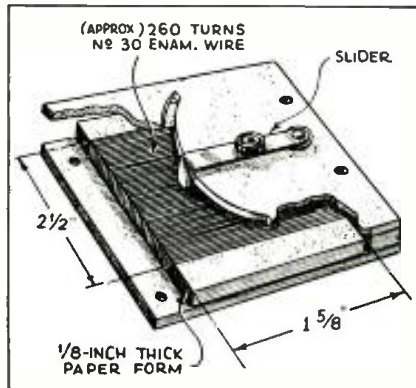

Fig. Q.314B, above
 Cut away view of set, showing coil.

WHAT SPEED ELECTRICITY?

(316) James Ohrbach, Boston, Mass.
 (Q.) A friend and I had a debate on the subject of the speed at which electricity travels. One contended that electric (and of course radio) waves travel at the fixed speed of 186,000 miles per second. The other side presented the theory that the conducting medium determines this speed. What is the true state of affairs?
 (A.) Until a few years ago we all had to believe that electricity travelled at a definite fixed speed, regardless of any retardation to the current flow. Now we know better, and find that in extreme cases, the actual speed of an alternating current effect can be retarded to only several thousand feet per second. As a matter of fact, telephone companies use a "phantom" or echo effect to prevent attenuation in certain circuits. This means that the phantom signal is retarded a measurable fraction of a second. Thus a man can actually hear his own voice echo after the directly transmitted signal has reached his ear.

DOES MOON INFLUENCE RADIO RECEPTION?

(317) Mr. Elmer Filsinger, Manhasset, L.I., N.Y.
 (Q.) In a back issue of "RADIO MAGAZINE" I noticed an article expounding the theory that the moon was responsible for much of the static which mars our radio reception. The author claimed: "It is a theoretical fact that the moon is charged with radium and produces lunar radium rays which though invisible and traveling with the speed of light, tend to penetrate the earth's atmosphere sufficiently to cause much disturbance in radio reception."
 "Proof of this fact was ascertained when experiments showed that always when the moon was directly overhead intensity of radio reception dropped off considerably, though when tests were made with the moon located on the opposite side of the earth, the reception improved tenfold and most of the disturbances disappeared."

Can you list any further experiments along this line?
 (A.) We can do no better than to quote from a recent letter received from the author of the article referred to by our inquirer.
 "Regarding the theory of the moon's radium rays I wish to say this: On my tour of the world in 1931 and 1932 testing radio reception in Europe, Asia, Africa and South America, I found this theory accepted by such scientists as Prof. Rezener of Germany and Dr. Blakett of England. The theory was accepted as established just a year or so ago in this country when Dr. Harlan T. Stetson of Ohio Wesleyan University presented his findings before an astronomers' body."

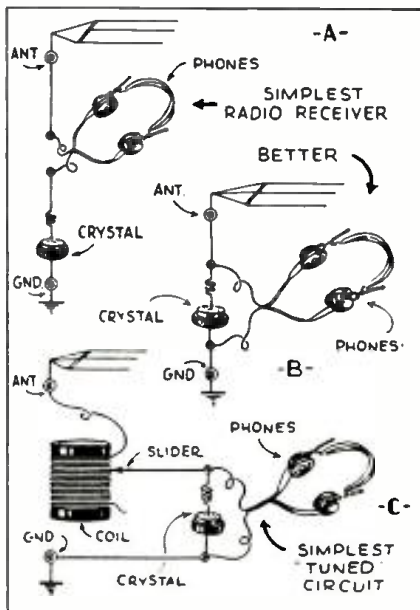
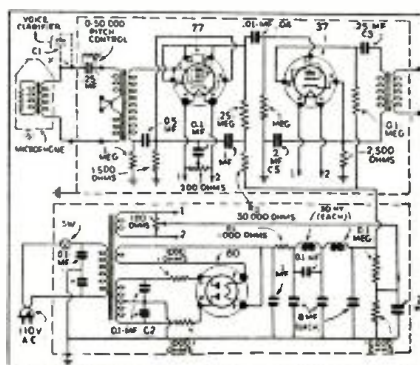

Fig. Q.314C, above
 The simplest workable receiver hookups.

Fig. Q.315, below
 Correction of "Amperite" pre-amplifier



CIRCUITS FROM FEBRUARY 1933- FEBRUARY 1935

Having received many requests from readers for simple circuits, we list here circuits of exceptional interest appearing in two volumes of **RADIO-CRAFT**. (Individual copies, 25c each.)

1 Tube

- "A 110 V. D.C. 'Megadyne'" (crystal and 1-38). May 1933, pg. 691.
- "1 Tube Crystal Superhet." (1-33). September 1933, pg. 160.
- "Beginners' Crystal and Tube 'Unit Chassis' Radio Set" (crystal and 1-33). October 1933, pg. 212.
- "The Beginner's '1-Tube' Crystal Superheterodyne" (2 crystals and 1-WD11 in three different circuits). September 1933, pg. 161.
- "The Schoolboys' 1-tube Receiver" (1-30). December 1933, pg. 343.
- "How to Make the Beginner's 1-Tube All-Wave Set" (1-33). February 1934, pg. 466.
- "How to make a One-Tube Loudspeaker Set" (1-33). May 1934, pg. 656.
- "A Beginners' 'All-Electric' 1 Tube Set" (1-12A7). June 1934, pg. 730.
- "An Italian One Tuber" (1-2A7). October 1934, pg. 211.
- "Build This Novel 1-Tube All-Electric All-Wave Set" (the 12A7 tube performs three duties). January 1935, pg. 405.
- "1 Tube Loudspeaker All-Wave Set (The 'Twinplex')." (1-19). January 1935, pg. 420.

2 Tubes

- "Now! Build the Megadyne 'N' Receiver" (1-32, 1-33). April 1933, pg. 604.
- "How to Make the Beginner's Power Crystal Set" (crystal and 1-31, 1-32). June 1933, p. 724.
- "An Improved Power Crystal Set" (crystal and 1-32, 1-33). July 1933, p. 36.
- "The Beginner's Crystal Superheterodyne" (2 crystals, 1-30 and 1-33). September 1933, pg. 161.
- "The Beginner's 'Unit Chassis' Crystal and 2-Tube Radio Set" (1-33, 1-34). November 1933, pg. 292.
- "—Now, As Predicted—a Pocket-Size Loudspeaker Set!" (1-6F7, 1-12A7). December 1933, pg. 334.
- "The Beginner's 'Unit Chassis' Crystal and 2-Tube Superhet" (1-33, 1-1A6). December 1933, pg. 342.
- "A 'Perfected' 2 Tube All-Wave Set" (2-30s). March 1934, pg. 523.
- "How to Build the 'Four-In-Two' Short-Wave Electric Set" (1-6F7, 1-12A7). January 1935, pg. 398.
- "How to Build a New 5-Meter Transceiver" (1-37, 1-41). January 1935, pg. 406.
- "A Short-Wave Band-Spread 2-Tube Portable Set" (2-30s). January 1935, pg. 410.

3 Tubes

- "Building a Battery-Operated 'Personal' Receiver" (1-34, 1-32, 1-33). May 1933, pg. 657.
- "How to Build the RADIO-CRAFT's Loop-Portable Receiver" (three tubes take place of four, 1-77, 1-6F7, 1-89). August 1933, pg. 73.
- "The Beginner's Power Crystal Set—with R.F." (crystal and 1-34, 1-32, 1-33). August 1933, pg. 90.
- "The Emerson 'Compact' Rewired for Dry-Cell 2 Volt Tubes." November 1933, pg. 278.
- "How to Make the Beginner's 'Pianatron' (1-30, 1-1A6, 1-33). January 1934, pg. 401.
- "A 3 Tube Superhet. Reflex" (Austria). March 1931, pg. 527.
- "Beginner's 3-Tube All-Wave Set" (1-34, 1-32, 1-33). April 1934, pg. 603.
- "A 3-Tube A.C.-D.C. All-Wave Portable" (1-78, 1-43, 1-25Z5). June 1934, pg. 734.
- "The 'Uni-Shielded' Short Wave Three" (1-34, 1-32, 1-33). June 1934, pg. 735.
- "A 3-Tube A.C. Short-Wave Set" (1-58, 1-2A5, 1-57). July 1934, pg. 28.
- "The Circuit of the General Electric C-30 Storage-Battery Operated Receiver (1-78, 1-77, 1-38). July 1934, pg. 33.

CLARION NO. TC-31 5-TUBE A.C.-D.C. SUPERHET.
(Broadcast band only; 110 V. A.C.-D.C. operation)

This set is designed for operation on 110 V. A.C. or D.C. lighting lines. If the set does not operate on D.C. in several minutes reverse the plug. The attached antenna should be laid out on the floor or hung out of a window. It may also be attached to an outside antenna if one is available. No ground is required and no attempt should be made to connect one as this will result in blowing a house fuse.

Service Suggestions

Circuit: The receiver uses a superhet circuit. The tubes used are: type 6C6 as combined oscillator and first-detector; 6D6. I.F. amplifier; 6C6, combined second-detector and

first A.F. amplifier; and, 43, output A.F. amplifier.

Aligning the Set: Only in rare cases will it be found necessary to adjust any trimmers. If the volume is low, everything else should be checked before attempting to align the set. The only case where the fault is in the alignment is when both low volume and poor selectivity are present. To align the I.F.: set the service oscillator to 456 kc., connect it to the control-grid of V1, and adjust the upper screw on the first I.F. transformer and the screw on the second I.F. (small round can) for maximum output. Now set the service oscillator to 1.400 kc. The signal should come in be-

tween 15 and 20 on the dial. Adjust the two trimmers on the tuning condenser for maximum output. Check at 600 kc. The lower trimmer on the first I.F. transformer is the oscillator coupling condenser and should not be changed.

Lack of Volume: Volume control partly open. Antenna condenser C1 open. One or more defective tubes. Check all voltages.

Hum: This may be due to one or more bad tubes, open filter condenser or shorted choke.

Set Dead: See if tubes light, if not, one of the tubes or the 200 ohm filament resistor is open. If operating on D.C. and tubes light, try reversing the plug.

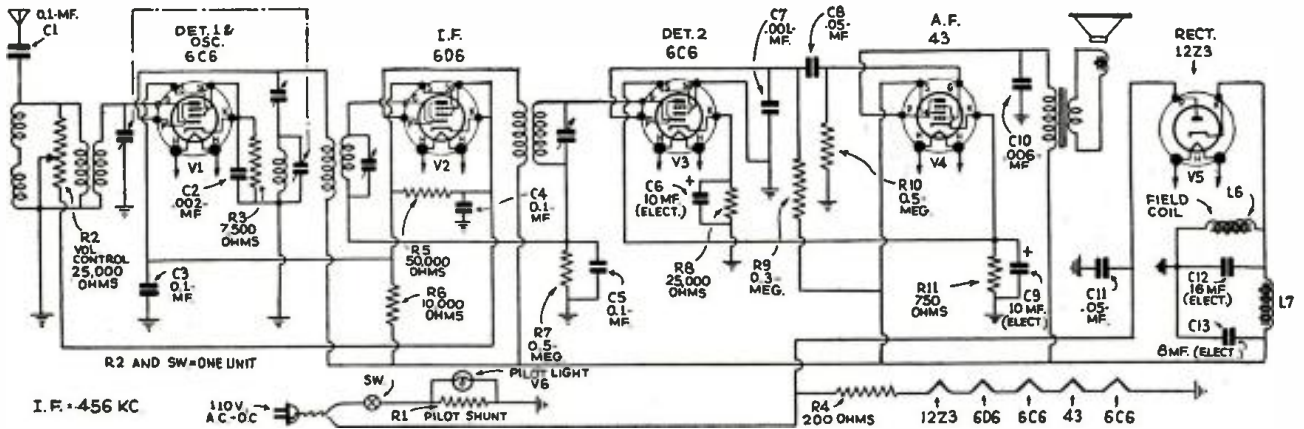

ERLA MODEL 4500 DUAL-WAVE T.R.F. 4-TUBE A.C. RECEIVER
(Frequency range: 540—4,200 kc.; 1 stage R.F.; 42 output)

Band-Selector Switch: This receiver is designed for operation on two different frequency bands. The frequency ranges of these bands are: 1,720 to 540 kc., and 4,200 to 1,500 kc.

Selection of the desired frequency band is made with the band-selector switch knob which is located on the lower right-front of the cabinet. When the band-selector switch is placed in the maximum left-hand position the receiver is operating on the 4,500 to 1,500 kc. band. For operation on the 1,720 to 540 kc. band place the band-selector switch knob in the maximum right-hand position.

To Align the Variable Condenser: It is important when aligning to follow the procedure carefully, otherwise the receiver will lack sensitivity and the dial calibration will be

incorrect.

(1) Connect the high output side of the oscillator to the receiver antenna lead and the ground to the chassis.

(2) Place the band-selector switch for operation on the broadcast band; tune the receiver to exactly 1,400 kc. on the dial and set the service oscillator frequency to 1,400 kc. Then bring in the 1,400 kc. signal to maximum output by adjusting the trimmer condensers located on top of the gang condensers.

Note: Generally the rear gang condenser section trimmer has to be adjusted to minimum capacity.

(3) Set the band-selector switch for operation on the short-wave band, tune the receiver dial to exactly 4 megacycles and set the test

oscillator to this frequency. Then adjust the trimmer condenser mounted on the coil located on top of the chassis for maximum sensitivity.

Voltage table: line voltage, 115; volume control, full on; wave-band switch, broadcast.

Tube Type	Plate Volts	S.-G. Volts	Cath. Volts
V1	230	80	2
V2	90*	80	3.5
V3	220	230	15**

Read all voltages from socket prong to ground unless otherwise specified. All filaments, 5.8V.

*Read from 375 ohm resistor R. to ground.
**Comparative voltage is not true voltage applied.

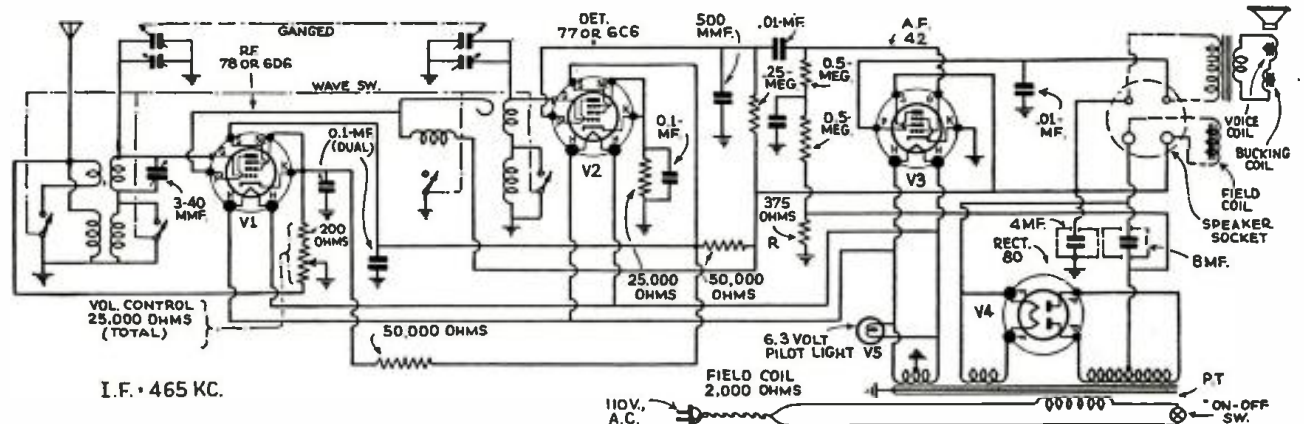

STEWART-WARNER (R-127 CHASSIS) MODELS 1271 TO 1279 ALL-WAVE SUPERS

(Five tubes. Frequency range 530 kc. to 23 mc.)

Range No. 1 (Broadcast) Alignment

(1) Connect a 400 to 500 ohm, 1 W. carbon resistor in series with the service oscillator output and the receiver antenna lead. This resistor must remain connected for all broadcast and short-wave adjustments in order to secure proper alignment of the antenna stage. Ground the receiver chassis and connect the oscillator ground lead to the chassis.

(2) (a) Tune in a 1,400 kc. service oscillator signal.

(b) Adjust trimmers No. 6 and 7 (range No. 1 broadcast detector shunt trimmer, and range No. 1 broadcast pre-selector shunt trimmer, respectively) for maximum output.

(c) Retune and check trimmers Nos. 6 and

7. (Do not touch trimmer No. 5 since this will change the calibration.)

(3) (a) Tune in a 600 kc. service oscillator signal.

(b) Adjust trimmer No. 8 (range No. 1 broadcast oscillator padding trimmer) for maximum output.

(c) Retune, and readjust the trimmer.

(d) Continue this procedure for maximum output meter reading. This procedure must be followed or the receiver will not be properly aligned.

(4) Repeat 2a, 2b, and 2c.

Range No. 2 Alignment

(1) (a) Tune in a 4 mc. service oscillator frequency, for maximum output reading.

(b) Peak-adjust trimmer No. 10 (range No. 2 detector shunt trimmer).

Range No. 3 Alignment

(1) (a) Tune to a 12 mc. signal, for maximum output.

(b) Peak-adjust trimmer No. 12 (range No. 3 detector shunt trimmer).

Range No. 4 Alignment

(1) (a) Tune to in a 20 mc. signal, for maximum output.

(b) Peak-adjust trimmer No. 14 (range No. 4 detector shunt trimmer). Detuning trimmer No. 14 and retuning the set until maximum output meter deflection is secured.

Align padder No. 15 at 12 mc.

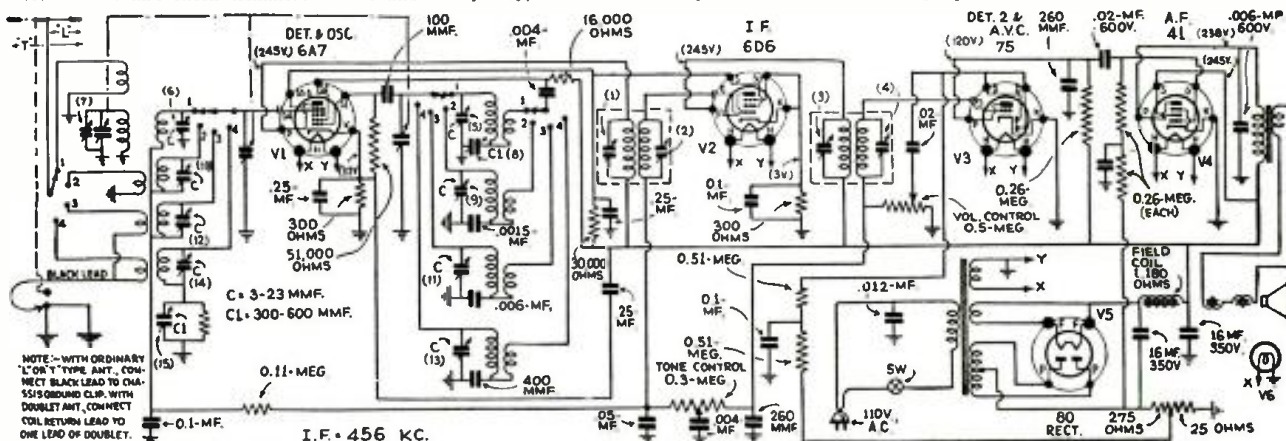

COLONIAL MODEL 652 5-TUBE BROADCAST-SHORT-WAVE SUPERHET

(Type 6A7 combined Det. 1 and Oscillator; type 75 A.V.C., Det. 2 and A.F.1; unique wave trap.)

The tubes and their functions are: 6A7—Oscillator and Det. 1; 75—A.V.C.—Det. 2—A.F. 1; 42—output A.F. 2; 80—rectifier.

In order to prevent interference from 600-meter code stations, when the receiver is located near the coast, a wave-trap is incorporated in the antenna circuit. Although this trap is shown in the diagram as a coil with a condenser (L-C), actually it consists of two multi-layer coils wound on top of each other with one end of each coil unconnected.

The voltage drop across the 0.5-meg. volume control, due to the diode current of the 75 tube, is used for A.V.C. voltage.

Alignment Procedure

The I.F. Stages:

(1) Set the service oscillator to 480 kc. and tune the I.F. transformers.

R.F. Alignment (Broadcast):

(1) Couple test oscillator to green antenna lead, leaving antenna connected.

(2) Set the service oscillator to 1,560 kc.

(3) Screw the oscillator padder condenser to approximately three-fourths maximum capacity.

(4) Turn tuning condenser all the way out. Adjust oscillator trimmer for maximum output.

(5) Set the service oscillator to 1,400 kc. and tune in its signal. Then adjust the V1 trimmer, on the variable condenser nearer the dial, for maximum output.

(6) Set service oscillator to 600 kc. and tune in its signal. Then slowly rotate variable condenser and adjust padder, C1, until maximum output is obtained.

Always use as low an output from the test oscillator as possible.

Short-Wave Alignment:

(1) Leave oscillator coupled to green antenna lead as for broadcast alignment.

(2) Set oscillator to 15 mc. and tune in its signal. Adjust trimmer on short-wave V1 coil, for maximum output.

Tube Voltage Chart

All measurements are taken between chassis and respective tube element.

Tube Type	Plate Volts	S.-G. Volts	Plate Volts
V1	190	70	190*
V2	220	70
V3	100
V4	210	220

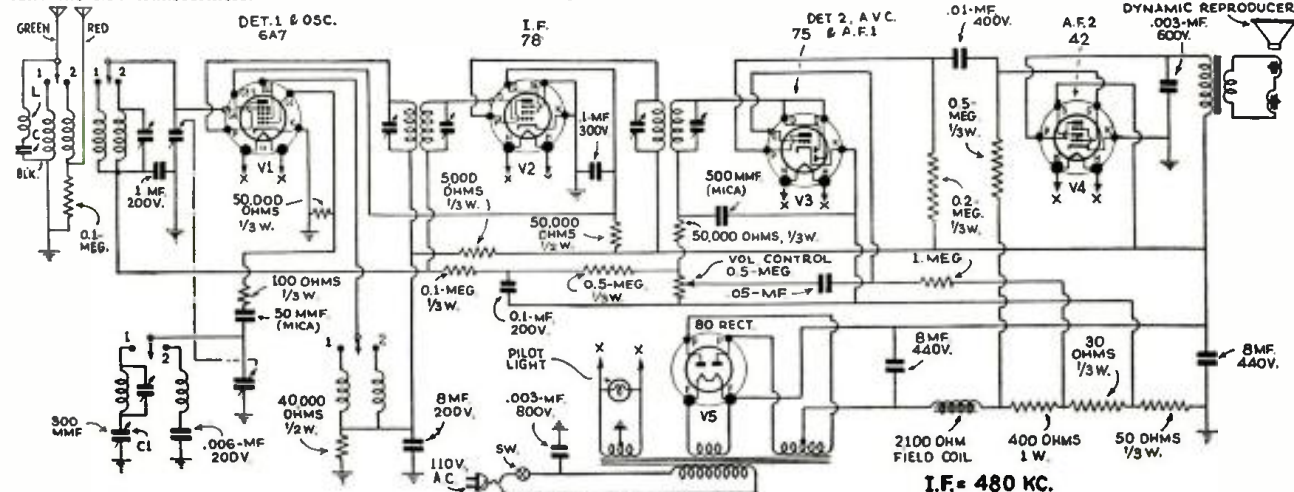

ALL-STAR JR

★ ALL-WAVE Superheterodyne ★

**Be Sure to Buy Your Kit From
SHORT WAVE HEADQUARTERS**

Here's the Little Brother to the famous ALL STAR! It costs much less to build but it's a Giant in performance. Even a novice can build it. The greatest of all home construction kits!

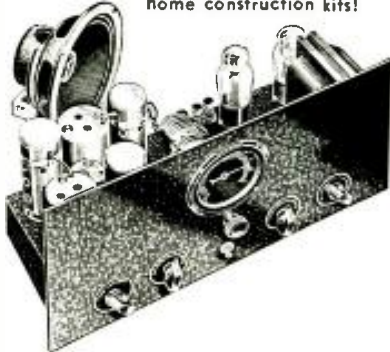

LOWEST "WHOLESALE" PRICES
Guaranteed when you buy from us. The COMPLETE kit of parts for the ALL STAR JR.—less tubes and Speaker, only \$27.03! If you prefer send only \$2.25 for Foundation Unit, pictorial layout, completely drilled front and sub-panel, wiring instructions, etc. You can buy the balance of parts as needed!

FREE Circuit diagram, parts list and data sheet and complete description of this amazing 5-tube All Wave Super-het! Send for it today!

Wholesale Radio Service Co.
100 Sixth Ave. Dept. C-35
New York, N.Y.

Send me complete ALL STAR JR. KIT at \$27.03
 Send me Foundation Unit complete at \$2.25
 Send me FREE Parts List, Data Sheet, etc.

Name.....
Address.....
City..... State.....

WHOLESALE RADIO SERVICE CO. INC.
NEW YORK ATLANTA
100 Sixth Avenue 430 W. Peachtree St., N.W.
Local Branch 219 Central Ave., Newark, New Jersey.

FREE Parts List — Data — Schematic
1935 RADIO SENSATION!

Kit of Parts **\$27.50**
Oxford 6" Speaker.....\$2.50
Sylvania Tubes.....3.95

BUILD YOUR OWN
ALL-STAR JR
ALL-WAVE Superheterodyne

A 5-tube Superheterodyne, all-wave receiver capable of world-wide radio reception. Its range is from 10 to 550 meters.
Sponsored by 11 world-famous manufacturers of radio equipment.
Send for 1935 184-Page Catalog

TRY-MO RADIO COMPANY
85 CORTLANDT ST. NEW YORK, N.Y.

179th Greenwich St., New York, N.Y.
Please address correspondence to Dept. C

BUILD THE 5-TUBE ALL-WAVE SUPER ALL-STAR "JUNIOR"

(Continued from page 535)

the elements (a glow on the glass bulb is merely fluorescence, and is not a fault in either tube or circuit) may indicate an error in connections and the circuit should be checked immediately for a short circuit.

If the tubes appear normal, set both tank condensers at 0 and swing the main tuning control back and forth over its range. If no station is heard, reset the tank condensers at 25 and try again. If the set is wired correctly, one of the many American broadcast stations will be heard. Once the receiver is working on the broadcast band, there should be no trouble in reaching the short waves where the maximum efficiency of the set becomes evident.

Performance

The performance of the new set is excellent. With the aid of the beat-frequency oscillator, selecting stations by carrier waves, the receiver picked up 61 phone stations more than 2,000 miles away between 4 and 10 p.m., on a Saturday night in Chicago. A plain "north and south" doublet with a 120 ft. lead-in and a 66 ft. top span served as the aerial. The following afternoon 38 of the same stations were received on the dial settings logged the previous day.

American broadcast reception is the equal of the majority of good, factory-made commercial receivers. As a test, a man who had never built a radio, in fact, an unemployed laborer, was employed to assemble a test model from the preliminary plans. It took half an hour to teach him to solder, and only 8 hours to complete the assembly. His only mistake was reversed volume control connections. The set performed as well as the laboratory model assembled by the engineers who designed the circuit!

List of Parts

- One Ohmite resistor, 300 ohms, R1;
- One Ohmite resistor, 3,000 ohms, R2;
- One Ohmite resistor, 50,000 ohms, R3;
- Two Ohmite resistors, 20,000 ohms, R4;
- Two Ohmite resistors, 500 ohms, R5;
- One Ohmite resistor, .2-meg., R6;
- Two Ohmite resistors, .5-meg., R7;
- One Ohmite resistor, 25,000 ohms, R8;
- One Ohmite resistor, 1 meg., R9;
- One Ohmite resistor, .25-meg., R10;
- One Ohmite resistor, 10,000 ohms, 10 W., R11;
- One Ohmite resistor, 15,000 ohms, 10 W., R12;
- One Thordarson power transformer, type T-7078;
- One Thordarson choke, type T-4102;
- One Thordarson Foundation Unit;
- One Crowe dial, No. 123;
- Four Crowe nameplates;
- Two Hammarlund star variable condensers, type SM140, C;
- One Hammarlund dual variable condenser, type MCD85X, Ca;
- One Cornell-Dubilier condenser, 3 sections each, 4 mf., 450 V., C1;
- Two Cornell-Dubilier condensers, .1-mf., 400 V., C2;
- Two Cornell-Dubilier condensers, .25-mf., 400 V., C3;



The "6 in. speaker" in the List of Parts. A plug and 24 in. cord are provided.

COMPLETE PARTS IN STOCK FOR THE

BUILD YOUR OWN
ALL-STAR JR
ALL-WAVE Superheterodyne

Write for Free Diagram and Parts List

Radio Electric Service Co.

N. E. Corner of 7th & Arch Sts., Philadelphia, Pa. 3145 N. Broad St. Philadelphia, Pa. 811 Federal St. Camden, N. J.

Official "ALL-STAR" Cabinet Fits ALL-STAR JUNIOR or SENIOR!

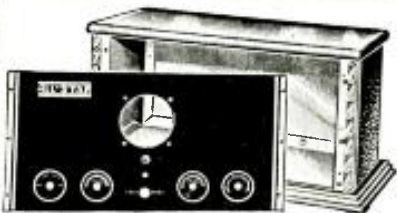

Available through Your Jobber
Crowe Name Plate and Mfg. Co.
1748 Grace St., Chicago, Ill.

GOOD NEWS ABOUT THE NEW 1935 OFFICIAL RADIO SERVICE MANUAL

The 1935 OFFICIAL RADIO SERVICE MANUAL is now ready for delivery. Turn to the announcement on page 570 of this issue, and read full particulars about this excellent book.

Please Say That You Saw It in RADIO-CRAFT

- Four Cornell-Dubilier condensers, .05-mf., 400 V., C4;
- One Cornell-Dubilier condenser, .03-mf., 400 V., C5;
- One Cornell-Dubilier condenser, .01-mf., 400 V., C6;
- Two Cornell-Dubilier mica condensers, 500 mmf., C7;
- One Cornell-Dubilier mica condenser, 100 mmf., C8;
- Two Cornell-Dubilier condensers, 10 mf., 25 V., C9;
- One set of Meissner coils for each frequency band, 540 to 1,200 kc. range, 1,100 to 2,300 kc. range, 2,200 to 4,400 kc. range, 3,800 to 8,900 kc. range, 7,750 to 16,000 kc. range, 15.5 to 30 mc. range;
- One Meissner input I.F. transformer, 370 kc.;
- One Meissner output I.F. transformer, 370 kc.;
- One Meissner heat-frequency oscillator coil;
- One Meissner R.F. choke, 16 mhy.;
- One Electrad potentiometer, with "log. taper" switch, 25,000 ohms, R1;
- One Oxford all-star 6-in. reproducer with output transformer and 24-in. cord and plug;
- One Belden all-wave aerial;
- One Belden all-star junior wiring kit;
- Three Erie Can tube shields and bases, 1½-in. mounting centers;
- Eight Oak wafer sockets, 1½-in. mounting centers as follows: two 7-prong sockets for 6A7 and 6F7 tubes, two 6-prong sockets for 77 and 42 tubes, three 4-prong sockets for the 80 tube, the reproducer plug, and the antenna coil, and one 5-prong socket for the oscillator coil;
- One S.P.S.T. rotary switch;
- One S.P.S.T. toggle switch;
- Three binding posts (2 "antenna" 1 "ground");
- Three grid clips;
- Two bar knobs for ¼-in. shafts;
- One RCA Radiotron or Sylvania 6A7 mixer-oscillator tube;
- One RCA Radiotron or Sylvania 6F7 combination triode-pentode tube;
- One RCA Radiotron or Sylvania 77 high-mu pentode detector tube;
- One RCA Radiotron or Sylvania 42 pentode power tube;
- One RCA Radiotron or Sylvania 80 rectifier tube
- Miscellaneous nuts, bolts, soldering lugs.

Operating Details

If all the wiring has been installed as the layouts indicate, you are now ready for a preliminary test. Install all of the tubes except the type 80 tube. Slip on the three tube shields at this time but use care that the covers do not press against the top terminals of the tubes. Plug in the speaker and a pair of tuning coils which cover part of the broadcast range. Turn the set on with the volume control and observe if all of the tubes light in a normal manner. Then insert the type 80 tube, watching the space between its filament and plates as you do so. If a brilliant orange or purple glow appears there, it indicates an error in your connections and the immediate need for shutting off the power and tracing your circuits. However, if it is satisfactory, connect the aerial and ground and link the ground wire from the aerial terminal nearest the ground post to the ground post. If your work is done correctly, you should be able to tune in broadcast stations by slowly turning the oscillator tank condenser and rapidly sweeping the detector tank condenser back and forth. After you hear the hissing sound of a station carrier wave, adjust the two tank condensers to the positions which give the loudest signal. Fine tuning may be accomplished by rotating the shaft of the twin tuning condenser. If you hear only a canary-like whistle during the tuning process, it indicates that the BFO switch is open and that it should be turned to eliminate the whistle. If no difficulty is experienced with local stations, open the BFO switch and adjust the trimmer screw on top of the BFO unit until a whistling note of pleasing intensity is heard. If the trimmers on the I.F. transformer have not been disturbed, no adjustment will be found necessary, as these units are pre-tuned at the factory to 370 kilocycles. If they have been thrown out of adjustment, you may be able by careful adjustment to bring



Build this New Low-Priced ALL-WAVE SUPERHETERODYNE for World Wide Reception

10-550 Meters, or 540 K.C. to 30 M.C.

Easy to Build—Splendid Performance

Sponsored by

- BELDEN MFG. COMPANY—4647 W. Van Buren St., Chicago, Ill.
- CORNELL-DUBILIER CORP.—4377 Bronx Blvd., New York, N. Y.
- CROWE NAME PLATE MFG. COMPANY—1749 Grace St., Chicago, Ill.
- ELECTRAD, INC.—175 Varick St., New York, N. Y.
- ERIE CAN COMPANY—816 W. Erie St., Chicago, Ill.
- HAMMARLUND MFG. COMPANY—424 W. 33rd St., New York, N. Y.
- OAK MFG. COMPANY—711 W. Lake St., Chicago, Ill.
- OHMITE MFG. COMPANY—636 N. Albany Ave., Chicago, Ill.
- OXFORD RADIO CORP.—350 W. Huron St., Chicago, Ill.
- MEISSNER MFG. COMPANY—2815 West 19th St., Chicago, Ill.
- THORBARSON ELECTRIC MFG. CO.—500 W. Huron St., Chicago, Ill.

AMAZING PERFORMANCE!

Distant stations in foreign lands come in on the ALL-STAR JUNIOR with splendid volume and clarity. The regular American broadcasts are available when you desire conventional entertainment. Thrill your family and friends with this receiver.

SENSATIONAL DESIGN!

Equal to the finest professional type communication receivers, yet you can build it yourself without special tools or test equipment. A soldering iron, screw-driver, and pliers are all you need to build the ALL-STAR JUNIOR. CONTINUOUS BAND SPREAD—over the entire tuning range, makes possible the separation of hundreds of stations that are jammed together at a single spot on the ordinary receiver dial. BEAT-NOTE OSCILLATOR—using the new 6F7 tube, brings in DX carrier waves inaudible on any other short wave receiver. SUPERHETERODYNE CIRCUIT—Five tubes in the latest design; does the work of 7 tubes! PRE-ADJUSTED I. F. COILS—Tuned at the factory to 370 kc. No adjustment required. ALL ELECTRIC—For 110-120 volt, 60 cycle standard A.C. house current. STANDARD PARTS—Ask your radio dealer or jobber for the ALL-STAR JUNIOR Foundation Unit that includes drilled sub and front panels, enlarged drawings of wiring and pictorial diagrams, three step assembly, and all instructions. Start with the Foundation Unit. Buy the remaining parts as you need them. For further information, fill out coupon below.



ALL-STAR JR
★ ALL-WAVE Superheterodyne ★

ALL-STAR HEADQUARTERS

360 N. Michigan Ave., Chicago, Ill.

Please send me Free Circuit Diagram, Parts List, and all information on the ALL-STAR JUNIOR.

Name _____

Address _____

City _____

State _____

Please Say That You Saw It in RADIO-CRAFT

BUILD YOUR OWN
ALL-STAR JR
ALL-WAVE Superheterodyne

A GREATER SENSATION THAN THE FIRST "ALL-STAR"

★ ALLIED ★
LEADS AGAIN—FIRST WITH FOUNDATION KITS!



Build the lower-priced new ALL-STAR ALL-WAVE JR. Tune: 10-550 meters. A great 5 tube Superhet that can be assembled at an amazingly low price. Features Band-spread tuning, world-wide reception, pre-adjusted coils, beat-note oscillator, excellent tone quality, etc. Easy to build. ALLIED is first with the FOUNDATION KIT. Only \$2.25 will start you building this great set. Foundation Kit includes drilled front and sub-panels, instructions, etc. ORDER THE NEW ALL-STAR JR. FOUNDATION KIT TODAY.

SEND FOR DIAGRAM & PARTS LIST

Allied Radio CORPORATION
 833 W. JACKSON BLVD., CHICAGO, ILL.

- Send me FREE Diagram and Parts List for building the ALL-STAR JR.
- Enclosed you will find \$2.25 for which you are to ship me the ALL-STAR JR. FOUNDATION KIT described above.

Name.....
 Address.....

Phila. Headquarters

BUILD YOUR OWN
ALL-STAR JR
ALL-WAVE Superheterodyne

Short Wave Receiver Kit
 Tour the Globe—Build this receiver now from the exact specified kit of parts as designed by the country's leading Short Wave Engineers.
 Write in for your copy of our New 1935 Catalog—Everything new, with an exclusive showing of the latest in

CUSTOM-BUILT SHORT-WAVE RECEIVERS

Name.....C
 Address.....
 City.....State.....

M. & H. Sporting Goods Co.
 512 Market St., Phila., Pa.

Federated Purchaser, Inc.
 is the logical source of supply for the remarkable new

BUILD YOUR OWN
ALL-STAR JR
ALL-WAVE Superheterodyne

FREE information and advice on how to build from engineering experts who know how! Be sure to ask for your FREE copy of our latest 1935 Catalog—full of bargains in Radios, Parts and Sound Equipment—at the Lowest Wholesale Prices!

Federated Purchaser, Inc.
 New York Chicago Atlanta
 25 Park Pl. 1331 S. Mich. Ave. 645 Spring St. NW
 Newark • Bronx • Philadelphia • Jamaica
 Pittsburgh

them back into alignment by adjusting each trimmer until you receive a distant station loudest. Accurate adjustments must be made with a Service Man's I.F. oscillator.

Before attempting to receive short-wave stations mount the front panel and dial mechanism, running the twisted wires from the dual pilot lights to the H and H terminals of the type 77 tube socket. Try each pair of short-wave coils in succession to make certain the receiver is operating on all ranges. If you encounter considerable electrical interference on the ranges covered by the high-frequency coils, it indicates a need for a doublet all-wave aerial recommended as optional equipment in the parts list. When the doublet is used, break the connection between the ground and the adjacent antenna post but leave the ground wire on the ground post.

Do not expect to get 12,000 mile reception within the first ten minutes. It will require two or three hours practice with the receiver before you can bring in extremely weak distant stations. Maximum results cannot be anticipated if parts other than those specified are used. The oscillator tank condenser is very critical in its adjustment. Use it only as a wave selector and tune with the dual condenser. When using the BFO circuit, tune for "zero" beat or a deep toned note. Seek steady "whistles" which are phone stations. Intermittent "whistles" are code stations.

"HIGH-FIDELITY" IN OLD SETS

(Continued from page 537)

Perts. According to these observers, a reproduction of 7,500 cycles indicated a quality of 90 per cent. Likewise they agreed that quality does not improve markedly as the reproduction range is increased to 10,000 cycles or above. It is also interesting to note that in the opinion of these experts the quality of a selection with the name "In a Village" actually decreased as the frequency range increased from 8,500-15,000 cycles; thus, too faithful a reproduction is sometimes considered detrimental to music enjoyment.

The noise level, (in addition to other important factors, to be discussed later), is the real reason for such high receiver cost. It is well known that most of the disturbing noises appear in the frequency range below 100 cycles and above 4,000 cycles (see Fig. 1B). In order to throw out such disturbances very large filter circuits are necessary in the power line.

First Steps in Improving Old Sets

The Service Man or amateur confronted with improving the reproduction of an old set should therefore first start by enlarging the filter circuits. A few electrolytic condensers (of 8 mf. 500 V.), a few of 20 mf. (of about 30 V. for the filament circuits), and some added chokes to the D.C., "B" source will do more to improve the reproduction of an old receiver than a great deal of work on other parts of the set. These fundamental improvements should be finished before the reconstruction of other receiver parts is started. In making these improvements it is important to select condensers which do not "sing" while connected to the power line, even when listening carefully. Electrolytic condensers with such a "hobby" are taboo. Service Men waste their money and time in using such parts because the desired high quality performance will never be obtained if the noise level is not kept down. The importance of first class condensers is proven by the fact that one well known company is using only the expensive mica type condensers for their higher priced receivers.

Further difficulties appear in the R.F. section of receivers by the so-called 10 kc. separation (see RADIO-CRAFT, December 1934, page 339, "Problems of High Fidelity Design"), i.e. the American broadcast band is over-crowded. All stations with an air line range of over 100 miles have a separation of only 10 kc. The so-called local stations, however, obtained a separation of 50 kc. from the Federal Communications Commission which provides the possibility for these local stations to furnish their listener not only with the usual 5,000 cycle frequency band but also with 7,500 cycles during the daytime by use of limited power radiation. The Federal Communications Commission has recently set aside a frequency band above 1,500 kc. in which the channel separation is 20 kc. permitting the radiation of a 7,500 cycle band width at any time of the day with full power (see RADIO-CRAFT, January 1935, page 396.)

Changing the Old Set

Methods for high-fidelity reception are available, but in trying to broaden the frequency range of an old set by damping the I.F. transformers etc. there occurs an unpleasant problem due to the so-called 10 kc. separation. In case the tuning of a receiver is broadened, (in order to obtain a high quality performance), no difficulties will appear upon tuning in the local stations, because of the 50 kc. separation. There is enough space between two local stations (see Fig. 2A), to avoid "monkey chatter" caused by touching of side bands from nearby stations.

However, powerful far-distant stations with a separation of only 10 kc. from the local station appear sometimes in an adjacent channel as loud as the desired station. In this case the receiver with a wide open input channel will pick up not only the desired local station but also some parts of the side bands from the unwanted DX station, (see Fig. 2B) resulting in a so-called "one and a half station reception" and terrible "monkey chatter."

It is therefore very important to have a variable input channel. Then, if there is a possibility of high-quality reception from a local station with distortion from a powerful DX station, the wide open input channel may be used. In all other cases the input channel should

READERS—

Send for your FREE supply

These handy post cards will make it easy for you to answer any of the ads. which appear in RADIO-CRAFT, and without cutting any valuable articles or data which you may wish to save.

Many times manufacturers request you to "clip the coupon" when answering their ads. Often this means destroying part of an article on the reverse page you may need later for reference. Save your RADIO-CRAFT issues complete. If you should ever want to see bound volumes, or certain copies of RADIO-CRAFT, the resale value of uncut issues is very much higher than that of mutilated ones. Furthermore, some numbers are already out of print, and the earlier ones cost 50 cents apiece. So send for a supply of these free post cards and use them in answering all RADIO-CRAFT advertisers.

(Date) _____

Gentlemen:

I noticed in the _____ issue of RADIO-CRAFT your advertisement, and would appreciate your sending me complete information and literature. As a constant reader of RADIO-CRAFT, I wish to keep the copies of my magazine intact, and I am taking this means of inquiry rather than mutilate my copy by clipping the coupon or cutting out the advertisement.

I am a—

<input type="checkbox"/> Dealer	<input type="checkbox"/> Short Wave
<input type="checkbox"/> Service Man	<input type="checkbox"/> Experimenter
<input type="checkbox"/> Public Address	<input type="checkbox"/> Jobber
<input type="checkbox"/> Engineer	<input type="checkbox"/> Manufacturer
<input type="checkbox"/> Professional Set	<input type="checkbox"/> Radio
<input type="checkbox"/> Builder	<input type="checkbox"/> Engineer

Name _____
 Address _____
 City _____ State _____

Please Say That You Saw It in RADIO-CRAFT

be narrowed to eliminate "monkey chatter." A variable input channel is further very useful if it is desired to pick up a certain DX station from an over-crowded part of the broadcast band. To apply the variable input channel in all these cases it is necessary to have a variable band width from 3,000 to 7,500 cycles.

The best way in which to obtain such a variable input channel is by the use of an I.F. transformer as shown in Fig. 3. This type of I.F. transformer has the usual tuned primary coil P, the secondary S, and in addition a new third coil T which is a so-called "trap-coil." The trap coil with its trimming condenser C3 is further connected with a variable resistor Rt of about 7,000-9,000 ohms. When applying the full resistance of Rt the trap circuit will not absorb much energy from the circuits P and S. Both circuits will have (according to their adjustment) the regular high gain and a selectivity of about 3,000 cycles which is useful for DX reception under even the worst of conditions. By decreasing Rt the response curve of the I.F. transformers becomes flatter and flatter, and upon taking out the entire resistance of Rt the I.F. channel is open for the passing of side bands up to 7,500 cycles.

The I.F.T. "Tertiary" Winding

In trying to reconstruct an old I.F. transformer, according to the new design some difficulties will occur in the makeup of the "tertiary" or third coil for the so-called trap circuit. According to obtainable information, there are no transformers of this design on the market; therefore it is necessary to construct such an I.F. transformer. This can very easily be done by buying 3 I.F. transformers of normal design. Upon disassembling one of these transformers, two trap coils are available. By adding each of the disassembled coils to each of the untouched transformers, the desired three coil transformer can be obtained.

However, not all I.F. transformers on the market today can be used for this reconstruction work. It is very important when buying the three I.F. transformers to look for transformers having shielding cans of large height to avoid undesired dampings of the added third coil in case of normal assembly work. If the I.F. transformers are well adjusted (as to coupling factor etc.) great care should be used in adding the third coil. Likewise care should be used not to move the primary coil and the secondary coil from their reciprocal distance (see Fig. 3B), thus saving much time later when the I.F. amplifier is lined up, and adjustments are to be made on the I.F. transformers. Generally, this advice cannot be obeyed entirely because some new arrangements may be necessary to obtain sufficient space for the added third coil.

The Condenser Method

A simpler method to obtain an I. F. amplified with a variable band without changing the I. F. transformers is shown in Fig. 4. Parallel to the trimming condenser C1, of the primary coil (P1), and parallel to the trimming condenser C4 of the secondary coil (S2), the fidelity control condensers C6 and C7 must be added. Both of these condensers should be ganged. By variation of the ganged fidelity condensers C6 and C7 the band width of the I.F. amplifier can be varied within any limit. One control condenser may sometimes be sufficient to vary the band of the I.F. amplifier. However, one side-band will be cut down more or less as shown in Fig. 5. In Fig. 5A is shown the selectivity curve of the untouched I.F. amplifier. Fig. 5B shows how the cut down of one side-band may appear by the use of only one fidelity control condenser. Fig. 5C indicates the selectivity curve by the use of two condensers according to the latter described adjustment method. A small three plate midret condenser may be used as a fidelity control condenser, i.e. two stator plates, and one rotor plate as made by Hammarlund, or any other similar design.

The adjustment of this type of I.F. amplifier must be made carefully in order to obtain good results. First set the fidelity control condenser C6 at zero and condenser C7 at full capacity. Then start with the second I.F. transformer. It may sometimes be necessary to cut a piece of the rotor from C7 to secure resonance because C4 may have too large a capacity. Then adjust the first I. F. transformer (C6 at zero) with an oscillator, by turning the two

ganged fidelity control condensers, the pass band of the I. F. amplifier may be varied as desired. The broken line in Fig. 5C indicates the resonance curve of each of the controlled circuits, and the full line shows the resultant band width of the I.F. amplifier, variable from 3,000 to 7,500 cycles.

Other Methods for "A.F. Band-Spread"

There are many other methods for achieving a variable band width but all are more or less complicated arrangements, and do not fit in for the reconstruction of old sets, since the above described two methods are complicated enough, especially if there is a demand to compensate for the loss of selectivity by broadening the I.F. pass band. This loss can be compensated for by a decrease in the frequency converter and I. F. tube bias, through the use of the variable bias resistors as shown in Fig. 6 where R1 and R2 are ganged either with the fidelity resistor Rt as shown in Fig. 3, or with the fidelity control condensers C6 and C7 as shown in Fig. 4. The tubes of the converter stage and the I.F. stage must of course have a variable-mu characteristic. It is well known that a small variation in the bias will change the output of a variable-mu tube, and so change selectivity. The decrease so caused will not materially effect the reproduction since high fidelity reception, with a wide open I.F. channel, can be obtained only from local stations, and in this case there is enough energy provided for sufficiently loud reproduction despite the decreased output of the "fidelity" controlled tubes.

The Oscillator in High-Fidelity Sets

Another part of the receiver which must be very carefully checked is the oscillator because of the necessity for greater stability than is commonly used if real high-fidelity performance is desired. There are many reasons for oscillator drift, one of the first to be discussed is the warm up of the receiver and especially of the converter tube. To avoid this trouble more or less it is advisable to use a chassis construction with "air condition" which simply means the tubes should be so arranged that enough air can be provided for cooling. The most efficient manner in which to accomplish this is by placing the tubes directly beneath the top of the cabinet in a horizontal arrangement as shown by some progressive manufacturers (Crosley model 173). The top-plate of such a cabinet has slits. All sensitive parts of the receiver (for example electrolytic condensers etc.) are isolated against heat radiation by means of an iron shielding plate. Between the shield and the tubes sufficient space should be allowed for a strong stream of cooling air. It may not be easy at times to reconstruct old receivers in the above described manner but if it is possible no Service Man or amateur should fail to apply this important improvement.

The best air conditioned receiver will not entirely avoid oscillator drift, with its awful boomy sound and screechy performance, unless some changes are made in the oscillator stage. A recommended improvement is the use of a separate oscillator tube coupled to a pentagrid condenser, meaning of course a step back to the former superhet. design, but also giving stability and high class performance. Coupling effects and pull-in effects often occurring between oscillator and R.F. circuits by the use of a pentagrid tube may be avoided in this manner.

A circuit of this type is shown in Fig. 7A. As oscillator a 76 tube is used, and as converter a 6A7. This circuit will be not very very strongly affected by extremely large incoming signals and the drift will be negligible. This circuit is used by Stromberg-Carlson on some of their new receivers. Another very interesting oscillator-converter circuit described by W. A. Harris (RCA) was recently shown at the meeting of the IRE, in Rochester. This circuit (see Fig. 7B) "a parallel-push-pull-converter" as named by the author with a duplex-diode-triode 85, seems to have some advantages over the present pentagrid converter. While this new circuit is not as yet used in industrial receivers it theoretically offers possibilities of being used in radio sets during the coming season.

More information on this very important subject will appear in forthcoming issues of RADIO-CRAFT.

Shhh! Shhh!

QUIET

Please!



Individually TESTED for NOISE

It Banishes Noise For Life!

ELECTRAD

New QUIET VOLUME CONTROL



Standard Replacement Unit with Power-Switch attached

NEVER before was such uncanny quietness made possible in a volume control. It required a radically new engineering principle and *individual testing* at the factory to assure its amazingly smooth, noiseless operation, which actually *improves* with use.



Current is evenly distributed over the flat outer rim of a rigid Bakelite ring, upon which gently glides a special—alloy floating contact shoe.

Molded Bakelite case, when mounted, extends only 1/2 inch back-panel. New-type power switch (approved by underwriters) may be instantly attached or removed by a single screw. Long, easy-to-cut aluminum shaft. All standard replacement values.



Resistance element baked on flat outer rim of Bakelite ring

Floating contact shoe glides over resistance element in straight path

Mail Coupon for FREE Descriptive Folder, and 1935 General Catalog of Resistors for Every Purpose.

from

RESISTOR

Headquarters

ELECTRAD 1935 CATALOG

Electrad, Inc.
175 Varick St., New York, N. Y.

Please send new 1935 Resistor Catalog. Check here for folder on new QUIET Volume Control.

Name _____
Address _____

RC-3

Please Say That You Saw It in RADIO-CRAFT



"Pretty Soft"

Not that I'm a softie . . . but with my new shaft of aluminum you can almost "bite" me off with a good pair of pliers . . . in fact a few swipes with a file and I'm down to the required size.

Just another refinement that makes it so much easier to use me in a replacement job. And do I work smooth? . . . ask thousands of servicemen the world over who always use CENTRALAB RADIOHMS for ALL their jobs. Don't say "Gimme a Volume Control." Specify RADIOHMS the next time you stock up.

The new RADIOHM offers smoother attenuation.



Every Radio Servicer Man should be a member of the Institute of Radio Service Men

Centralab
Division of MILWAUKEE Globe Union Mfg. Co. WIS.
RADIOHMS—RESISTORS
MOTOR RADIO SUPPRESSORS

VERSATILE 10-TUBE 36-WATT P.A. AMPLIFIER

(Continued from page 546)

of this tube was set at 100 to care for long mike transmission lines. Its output is connected to a carefully engineered resistance-capacity coupler, with a 0.5-meg. potentiometer volume control to supply the grid of the following tube. A tone control is shunted across the movable arm of the volume control to the chassis to prevent high frequency peaks from overloading subsequent stages. Also in this position, suppression of the higher audio frequencies at low volume does not cause the "empty barrel" effect which is characteristic of many sound systems.

Heretofore, it was considered impossible to mix two crystal microphone circuits without serious losses in signal strength. The solution of this problem brought about a new arrangement in P.A. systems which is so simple and logical it seems impossible that it should previously have escaped attention. A second 57 tube was employed in an identical circuit to the first 57 for the other microphone. What could be more logical? A circuit refinement, giving further elasticity in control, was the use of a 1. meg. center-tapped volume control. This provided the option of connecting a radio or phono-pickup circuit to the amplifier without the phono circuit going through the 57 tube. Thus the output of one microphone may be faded out into music from the phono-pickup, while the other may be used for announcements.

The problem of mixing the output of the two 57 tubes was not so easy. Every type of tube which could be used was carefully analyzed from a theoretical viewpoint. The solution lay in the well-known "Wunderlich" double-grid tube which presented every desirable feature required for mixing the output of the two 57 tubes. In the "Wunderlich" 2½ V. twin-grid tube, each grid has the same radii with respect to the cathode and a common plate. This tube not only served to mix the two microphone circuits but secured an amplification of 9 with the distortionless characteristic of a triode.

Intermediate Stages

High fidelity, resistance-capacity coupling, with a half-megohm master volume control in the succeeding grid circuit gave complete control over the volume and gain of the amplifier. At this point the voltage gain, or mu, was only 900 or approximately 59 db. above the level of the microphone.

We needed plenty of good distortionless amplification ahead of the power stage and adequate handling capacity. Pentode tubes with the harmonic distortion were rejected without second thought.

Certain features about the 53 tube, which is normally used for class B work, looked attractive. In a test circuit, with its two grids tied together for the input and its two plates connected in parallel, gain curves were plotted at different plate voltages. With 294 volts on the plate and 6 volts grid bias, a maximum mu of 25 was secured. The best results were obtained with a high plate load impedance.

A special transformer had to be designed to handle this signal and transfer it to the grids of the push-pull-parallel 2B6 tubes. So efficiently was the design of this transformer carried out that a gain of 4 was secured without the loss of tone quality in the lower register. Neutralization of the power stage maintained the high frequency fidelity characteristic far beyond the range of ordinary amplifiers.

A master tone control was incorporated in the plate circuit of the 53 to give complete control after the individual circuits had been adjusted to the correct balance.

The Output Stage

The power stage utilizes the new super triode 2B6 power tubes in parallel-push-pull with 350 volts on the plates. The signal gain with this arrangement is a mu of 6.5 (much higher than any other power triode). The power output is terrific. The 36 watts output require an output transformer almost as large as the power transformer. It is designed to handle transient peaks of 50 watts, or 40 watts steady output. The ratio of turns in this transformer was calculated by taking the square root of 5000, which is the net plate load impedance of the four tubes, divided by each output impedance which was desired. The first secondary winding was tapped for 3, 6, 9, and 15 ohm voice-coil circuits. The second winding was tapped for 250, 500, and 1000 ohm line circuits. The wire in each section is capable of carrying the entire output—hence the size of the transformer had to be large to accommodate the extra heavy wire and insulation.

The Power Pack

The power-pack presented no particular difficulty; it had to be capable of handling about 200 watts and the output had to be absolutely hum-free. The two 5Z3 tubes filled all the requirements for rectification. Only the filament-type 5Z3 may be used, however, as the voltage drop in certain makes of heater-type 5Z3 is so low that the filter condensers are endangered. A four choke, choke-input filter circuit, with 1000 volt paper filter condensers in the buffer positions, completely smoothed out the 120 cycle ripple from the rectifier.

The push-pull input transformer picked up a 60 cycle hum current from the magnetic field of the power transformer and a novel method was devised to cancel this transient pickup. One line of the A.C. power supply proved to be 90 degrees out of phase with this transient current. Connecting this side of the A.C. line through a 50,000 ohm resistor to one end of the transformer primary completely cancelled the hum which this transformer had picked up. The overall hum level is lower than the finest A.C. operated home radio sets.

The Speakers

A bleeder circuit of four 1000 ohm resistors provided with taps, permits field supply to four 1000 ohm speaker fields at 100 volts each. It also aids materially in good regulation of the plate supply, and 10 watts per speaker field is secured. The speakers should be of the inductive "hum-bucking" type to cancel the slight ripple of A.C. present in the bleeder circuit. Plug-in connections are provided for instant connection of one to three dynamic speakers. The three line impedance values of 250, 500, and 1000 ohms permit the use of as high as 36 permanent magnet dynamic speakers with one watt each, or 72 magnetic speakers with ½-watt each. The magnetic speakers in this arrangement, with the net impedance of the speakers matched to the nearest output tap, would give each about the same volume as when used in an old-time radio with push-pull 112A tubes. This would be sufficient for 3500 students in a 72 room school building. With four 12½ in. dynamic speakers and suitable baffle mounting for directional effect, there should be no difficulty in bringing audible signals to 10,000 people assembled in the open.

When looking for trouble—CONSULT "Actual Troubles" in Commercial Radio Receivers. The main volume, which consists of over 45 diagrams and 200 pages, covers over 500 different models. The supplement will cover 300 more. This supplement is free! The author, Berttram M. Freed, is considered one of the foremost authorities on Radio Servicing. If your jobber or Radio mail order house cannot supply you with this great Book Value—Send your order direct to us. Money back guarantee if not satisfied after ten days. Postpaid \$1.00.

SERVICEMEN'S PUBLISHING CO.
136 Liberty St., New York.

SPEAKER REPAIR KITS

SERVICEMEN AND DEALERS

These Kits contain everything necessary for the efficient repair of speakers. All Kits backed by Multiplex Guarantee of Quality.

You can't afford to be without it.

EXCLUSIVE TERRITORY OPEN FOR JOBBERS

MULTIPLEX RADIO SERVICE, INC.
89-4th Avenue Brooklyn, N. Y.

Send for this FREE Attractive Folder

Fig. 1
This chart shows clearly the performance characteristics of the 36-watt crystal microphone amplifier.

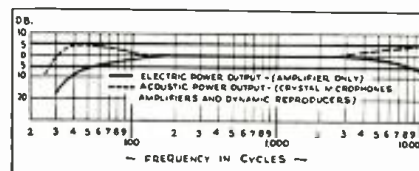
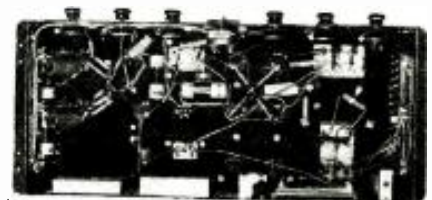

Fig. 2
Under-chassis arrangement and wiring.



Please Say That You Saw It in RADIO-CRAFT

The Operation

Some interesting experiments which dramatically demonstrate the power of this amplifier may be made by connecting a small length of resistance wire across the low impedance output of the amplifier. Slowly draw a bow over a violin string in front of the microphone; it will burn the wire or heat it close to the burning point. Let the microphone hang out of a window and pick up traffic sounds two or three block away! Sparrows chirping fifty feet away from the microphone can be heard clearly.

A 40-watt lamp bulb with 363 ohms (hot) internal resistance designed for 120 volt operation will burn brightly on either the 250 ohm line tap or the 500 ohm output tap with a steady signal fed into the mike. It is interesting to cause the light to burn out, by drawing a bow across a violin string close to the microphone!

The operation of the amplifier is extremely simple. A ruby pilot light indicates when it is turned on. The first two controls on the left adjust the volume of each input circuit. The third control is the master volume adjustment. The power level meter in the center makes the operator an approximation of the volume output at any instant, thus permitting manual compensation for various features presented before the microphone. The fourth and fifth controls are the individual microphone tone adjustments, while the last control to the right is the master control and switch combined.

In addition to the crystal microphones, any type microphone except the condenser variety, which requires a polarizing voltage, may be adapted to the input. Velocity ribbon microphones with suitable coupling transformers perform excellently with a very desirable directional effect which is often necessary to eliminate feedback. The moving coil microphones are satisfactory for wide angle pickup where feedback is not a factor.

For smaller installations than those requiring 36 watts of power, a junior model of this amplifier has been built, using only two 2B6 tubes to secure an output of 18 watts. The overall gain of the smaller amplifier is about 5 db. greater than the 36 watt instrument. All the other features are the same in the junior model.

So far as is known this is the first unit amplifier for dual microphone and phono input which has been designed for such high gain without loss of quality. It is now available.

REPLACEMENT STATUS OF THE NEW TUBES

(Continued from page 525)

fore be a triode. Furthermore, the last number does not allow for a heater in addition to three elements. These deductions together with the first numeral, indicate the tube must be a 2.5 V. filament triode. This is more information than can be deduced from the type number of most other tubes numbered according to the new system, but in all cases the first number will supply the filament or heater voltage. The advantage of the system is that one fact about a tube will usually assist in remembering other facts.

Another helpful factor in the situation is the correspondence which exists between certain 2.5-volt heater tubes and some of the 6.3-volt heater tubes. These tubes—shown in pairs on the chart, Table II—are identical except for heater voltage and current.

(Note: Although descriptions of the new tubes have appeared in RADIO-CRAFT as fast as the tubes were announced, a summary of their outstanding characteristics, which appeared in October, 1934 issue is of special interest. The title is, "How to Use the New Tubes." The data scheduled to appear in the forthcoming issues is more detailed.—Editor.)

With the aid of these two "memory shortcuts", and with the clear understanding that new type tubes are not designed to replace earlier types, it is hoped that the beginner in radio will find helpful the articles which follow, on tube substitutions.

MODERN THEORY OF ELECTRICITY

(Continued from page 524)

which are interlocked and revolving at inconceivably great speeds in regular orbits around the positive nucleus. Thus it is apparent that energy is associated with and locked up in every atom. (Fig. 1)

The Proton. The nucleus may be thought of as a charge of positive electricity or "proton" concentrated at a point, at the center of the atom, around which the electrons—restrained in their orbits by it—revolve. (Fig. 1.)

We know very much less about the positive nucleus than we do about the electron. It may consist of several positive units of charge—or positive electrons—locked together in some manner by the help of the negative electrons, but the nucleus as a whole must have a positive charge to hold the atom together.

The Electron. It is believed that atoms are made up of minute particles of negative electricity—termed "electrons"—and of a central nucleus in which practically the whole mass of the atom resides.

The number of electrons in the universe is constant and unvarying. Electricity can neither be created or destroyed.

Electrons can be set in motion and caused to be moved from one location to another, thus producing what are known as electrical phenomena.

The "E. M. F." But electricity or electrons—can be neither made nor eradicated. It is therefore evident that electricity can be neither "produced" nor "generated" in spite of the fact that the term "generation of electricity" is frequently used. When a statement is made that "electricity is generated by a battery or dynamo" what is really meant is that the battery or dynamo is forcing some of this electricity, which is already in existence, to move.

It exerts an "electro-motive" force (abbreviated e.m.f.) measured in volts. A battery or dynamo does not generate electricity in the wires connected to it any more than a pump, which is impelling a stream of water in a pipe, generates the water.

The dry battery and storage battery are two methods of exerting an electro-motive force, by splitting up the substances used into atoms by chemical separation. This will be explained later.

The dynamo is another method of exerting an e.m.f., by cutting a copper conductor with magnetic lines of force; electricity and magnetism are so closely associated that when one is present the other plays an important part. Our next concern is atomic separation by chemical process.

The existence of an electric current in any circuit means that energy in some form is being liberated at the generating source; and the continuance of this current necessitates the continuous expenditure of energy. In the case where the current is supplied by a dynamo driven by a steam or gas engine, the source of the supply is the coal and the place where the energy is being liberated is in the furnace. Coal contains large supplies of energy, which it readily liberates in the form of heat, and which, after such transformations, may appear in a circuit in the form of electrical energy, and is used for lighting, running motors, energizing radio sets, and can even be stored in batteries.

The coal becomes oxidized or burned up in the process, and the quantity of energy that can be obtained is clearly limited by the amount of coal consumed or burned.

In most cells the fuel consists of zinc and acid, which are consumed, but which, instead of giving out their energy in the form of heat, give it out directly in the form of electric current.

A cell is in reality nothing more than a little furnace in which zinc instead of coal is used as a fuel, and in which the "burning" is not simple oxidation.

Primary cells consist of three essential constituents for the production of e.m.f., viz., a positive plate, a negative plate, and an exciting liquid (termed the "electrolyte").

According to the nature of the plates and the liquid, a certain difference of potential (or "p.d.") is set up between the plates. When the cell is on closed circuit, i.e., when the plates are connected through an outside circuit, chemical energy stored up in the cell is converted into electrical energy.

HARD-TO-FIND

TROUBLE SPOTS

Now Quickly Located!

UP AND coming service men know inefficient equipment means lost time, inaccurate work and unsatisfactory results. More and more, they are turning to the Readrite No. 730 Tester because it takes the guess work out of servicing and enables them to quickly and accurately locate trouble spots.

The No. 730 Point-To-Point Tester is designed especially for speedy and efficient servicing. It is extremely flexible. Voltage can easily be checked in any tube circuit. Also measures resistance, capacity and continuity. Tester socket terminals are arranged according to RMA standards. It is unnecessary to remove chassis from cabinet when localizing defects.

This tester includes two meters—one for reading AC, the other for DC. These meters are rugged, compact and accurate. Separate meter ranges are made possible by connecting to a single pair of jacks and using the selector switch. DC ranges are 15, 150, 300 and 600 volts. (1,000 ohms per volt). Milliampere ranges are 15 and 150. The AC voltmeter ranges are 10, 25, 150 and 750.

YOUR JOBBER CAN SUPPLY YOU
At the dealer's net price of \$18.60

READRITE METER WORKS
142 College Ave. Bluffton, Ohio

MAIL COUPON FOR CATALOG

Readrite Meter Works
142 College Avenue, Bluffton, Ohio.
Send me catalog on Readrite No. 730 Tester and folder proving Readrite leadership.

Name.....
Address.....
City..... State.....

Please Say That You Saw It in RADIO-CRAFT

SERVICEMEN!

help yourself to
GREATER PROFITS

There's no doubt about it. I can help ANY serviceman who is willing to invest a little time and study with the aim of winning better jobs and greater profits. And I can do it at a low price which will amaze you.

Sprayberry's Practical Mechanics of Radio Service will help you in a hundred ways—just as it has helped countless others, many of whom found ordinary courses too costly, too elementary or impractical for their needs. Certainly you owe it to yourself to investigate!

NEWS FLASH! Several new lessons on the use of the CATHODE-RAY TUBE or OSCILLOGRAPH have just been added to the Sprayberry course—at no increase in cost to you. Don't miss them!

F. L. Sprayberry 2548 University Pl., N.W. Washington, D.C.

Without obligation on my part, please send details of your system. Also tell me how I can get the new Sprayberry DATA SHEETS (worth \$3) at no additional cost.

Name

Full Address

RC-3/35

SPRAYBERRY'S PRACTICAL MECHANICS OF RADIO SERVICE

"The reproduction had to be faultless"

"Wright-DeCoster Speakers have proven even more successful this year in Hollywood at A Century of Progress. Their exceptional tone quality, faithfulness of reproduction and rugged dependability have made me feel that Wright-DeCoster Speakers are the best possible. As our installation was in a large theatre in a Fair, the reproduction necessarily had to be faultless. Your Speakers fulfilled every requirement." (Signed) J. D. Keener, A Century of Progress International Exposition, Chicago, 1934.

Wright-DeCoster makes Reproducers for every purpose. Write for full information regarding your needs.

WRIGHT-DeCOSTER, Inc.

2251 University Avenue, St. Paul, Minn.
Export Dept. M. Simons & Son Co., 25 Warren St., New York. Cable Address: Simontrice, New York



The general action of any type of primary cell may be briefly summarized as follows:

The negative plate, generally zinc, dissolved gradually in the electrolyte, liberating hydrogen.

The positive plate—copper, carbon, or platinum—remains unaffected, and a film of hydrogen gas accumulates over it. This collection of hydrogen gas bubbles is called "polarization." To prevent polarization (which increases the resistance of the cell, and sets up a counter e.m.f.) a fourth substance is used—termed a "depolarizer"—in the cell to absorb the hydrogen. As we have seen before, however, the current really consists of an electron flow from the negative to the positive terminal. The conventional way of considering the direction of the flow of the electric current is from the positive to the negative terminal. Thus the negative plate supplies the electrons, which flow from it through the outside circuit to the positive plate, and through the cell to the negative plate, are set in motion by the chemical action of the cell.

The e.m.f. or difference of potential (d.p.) between the terminals on open-circuit depends entirely on the substance used (the positive and negative plates, and electrolyte), and not on the size of the cell.

A diluted solution of sulphuric acid in water or a saturated solution of salammoniac are commonly used as electrolytes.

The resistance of the cell depends upon the area of the plates immersed, their distance apart, and the specific resistance of the liquid. The larger the plates, and the closer they are together, the less is the internal resistance.

The advantage of a large cell is not in the value of its e.m.f., but in its smaller resistance, owing to the area of surface contact of the plates; also, it contains more energy stored in chemicals and lasts longer.

(This instructive article is published by courtesy of R.T.G. NEWS).

THE EARLIEST LOUD-SPEAKERS

(Continued from page 523)

as the baffle of our modern dynamic speakers).

Since the end of the seventeenth century, mariners have used megaphones to transmit orders. In 1670 units were built in England which enabled the voice to be heard at several miles. These horns were about 23 ft. long and about 2 1/2 ft. in diameter. Similar experiments took place at the same time in France and it was even established that a relationship existed between the length of the horn and its carrying distance. Even now megaphones are generally used by mariners to transmit orders against the wind (Fig. 2). They are conical tubes the length of which sometimes reaches 3 ft. One end is provided with a mouthpiece, while the other end carries a short, large cone. The manner of operation of such megaphone is quite complicated.

The acoustical tube, in the shape of a cylindrical pipe in which sound waves keep a constant energy, has also been well known for a long time. Fig. B is a reproduction of an engraving which dates from the time of the "Director." It represents an amusing acoustical experiment "The Voice of the Invisible Singer." A singer located on an upper floor of a house sang into the mouthpiece of an acoustical pipe. The sound was transmitted to an amplifying box which seemed to be well designed and apparently suspended entirely by wires with no connecting pipes or other sound source. The listeners were naturally mystified as to where the sounds originated.

The hornless loudspeaker is much older than any of the primitive loudspeakers made of an ordinary telephone receiver and a conical horn. As a matter of fact Elisha Gray built, in 1879, the first hornless speaker which is shown in Fig. 3. The diaphragm was made of soft iron and emitted sounds when it was vibrating under the influence of the electro-magnets shown in the illustration.

It is highly probable that to these examples can be added a large number of others just as novel and perhaps of far greater antiquity. No boast that the field is exhausted is intended. While the word, "loudspeaker" (reproducer) is of comparatively recent origin, it is certain the device itself is not.

Please Say That You Saw It in RADIO-CRAFT

ORSMA MEMBERS' FORUM

(Continued from page 547)

the same in the whole circuit (a series circuit),

may be found from the formula $I = \frac{E}{R}$, where

either of the respective measurements of voltage

and resistance may be substituted as $I = \frac{20}{133.33}$ or

$I = \frac{30}{200}$, the result being .15-amperes in either case.

To determine the factors of voltage and resistance with an ammeter, set up a circuit as in Fig. 1B. Take a reading of the current passing through "x" by putting the ammeter in series with it, and record the reading. Take a reading through "k" and record it. Substitute in a similar manner in the formula

$R_x = \frac{I_k \text{ times } R_k}{I_x}$, where I_k is the amperes

through "k," I_x the amperes through "x" and R_k the known resistance. The voltage may be found by substituting in the formula $E = R \times I$, using either set of factors as before.

ARNOLD WOLF

The applications of Ohm's law to radio problems are numerous. However, since many Service Men do not fully realize just how this law can be applied, we feel that the above information will be of use to many ORSMA members.

TESTING A.F. AMPLIFIERS

RADIO-CRAFT, ORSMA Dept.:

For testing the A.F. stages of a radio set by the stage-by-stage method, I use a test lead with a series condenser of 500 mmf. connected to one side of the 110-V. A.C. line.

In using this method, connect the other end to the grid of the power tube, with the receiver turned on. If you hear a buzz from the speaker, that part of the amplifier is O.K. Next connect it to the plate of the first A.F. tube, then to the grid of this tube. Then connect it to the plate of the detector tube. As you move the test lead from one point to another and you hear a buzz at each point you know that part of the amplifier is working.

This will give a general idea of the condition of the A.F. stages of a set. The method of connecting the device is shown in Fig. 2.

RUSSEL E. JAMES

A SOLDERING IRON KINK

RADIO-CRAFT, ORSMA Dept.:

In our shop, we use a method of keeping soldering irons tinned, which may be of interest to members of the ORSMA.

The tip of the iron is bent almost 90 degrees so that when it is laid down flat in the holder, the bent end extends down into a well of solder in the holder. The electric iron is always nicely tinned in this way.

The well is nothing more than a piece of iron about 3/4 to 1 in. in diameter in which a 3/8-in. hole is drilled almost through. This iron disc is then cemented on a piece of asbestos with asbestos cement, as shown in Fig. 3.

At intervals of about 2 hours we drop a small piece of rosin into the well, which makes soldering easier and helps to keep the iron tinned.

R. D. BERGEE

SERVICE MEN'S UNION

RADIO-CRAFT, ORSMA Dept.:

I live in Hamilton, Ont., Canada, and carry on a radio service business of my own. Things have been very tough in this town in the line of radio service, especially regarding "price cutting" by a lot of local companies and stores.

I think it is high time a local "Union" was formed to put things back to normal.

For example a local store (not to mention the name) recently laid off their two very competent Service Men, who incidently were working for \$10.00 and \$12.00 a week, and advertised for a Service Man. Their proposition offered the Service Man 30c per call for local jobs and 50c for out-of-town calls. Now, when you figure it out at 7c a street-car ride (for you had to supply your own transportation to and from the call) you made the large sum of 16c per call. A nice way to make money fast?

That is why I am taking this opportunity of writing to you. I have been in business approximately 4 years. I used to be in partnership with another local man but business was so bad and jols had to be done for next to nothing so we had to give it up. I would like to join the ORSMA.

D. W. CLINE

This letter from Mr. Cline is only one of numerous messages on the same subject from all parts of the United States and Canada. The service business is sadly in need of organization. But this organization must be in the form of local organizations banded together into a national organization in order to improve present conditions.

The ORSMA offers the nation-wide organization, but our hands are tied, unless the individual members in local towns and communities group together and form local organizations, much in the way that labor unions are organized. If the members in any city or town will get together, we will do everything possible to help the cause along. Let's cooperate, fellows—for the good of every member.

HOW TO READ RADIO DIAGRAMS

(Continued from page 526)

represented in the zig-zag symbol of a resistor and once memorized is never forgotten.

(17) Where the resistance value in the circuit is to be varied we have recourse to an arrow-head to indicate the moving contact arm.

(18) If it is desired to maintain the fixed value of the resistor in one portion of the circuit, while tapping off along the length of the resistor, a third lead is required from the unit in order to provide this "potentiometer" connection.

(19) Wires that cross but do not connect are so indicated by a definite jump. A connection can never be mistaken for a jump if, as shown, a dot is used to represent the juncture.

(20) The rectifying properties of various metallic crystals is usually effected by means of a contact wire or "catwhisker" that lightly rests upon the surface of the crystal. In symbolic form the catwhisker and crystal are represented by respectively an arrow-head resting on a block; the crystal is mounted on a slab. For connecting more than two leads a more extensive plug-in device must be provided than is represented in illustration 15. Thus, in illustration 20 is shown, for example, a 4-prong plug and its socket. The solid metal prongs of the plug are represented in the symbol by dots; and the matching portions of the socket, by circles.

(21) Imagine trying to draw the switch illustrated under "physical," every time you wanted to represent an off-on switch! How much more simple it is to draw an X within a circle as shown under "symbol."

(22) Unfortunately, the single-pole, single-throw symbol represented in illustration 21 cannot be carried out for a multi-throw or multi-contact switch; hence the symbol, showing an arrow for the switch arm, and the number of dots necessary to represent the contact points or number of "throws."

(23) Where several circuits are to be switched at one time a switch blade must be provided for each circuit; in the symbol, a knife switch is represented, connecting two circuits into either of two additional circuits.

(24) To prevent the accidental burn-out of valuable apparatus it is customary to provide a fuse consisting of a strip of metal that will melt before the current reaches dangerous proportions. Both the screw (A) and plug-in (B) types are represented by the same symbol.

(25) The negative and positive terminals of a cell are represented by, respectively, a short, flat and long, thin line—two or more such groups represent batteries.

(26) The magnetic type of phonograph pick-up consists of an iron armature in relation to a coil, the armature being directly connected to the needle. This relationship is indicated in the symbol, the armature and needle being represented by an arrow.

(27) Reproducers are generally referred to as being either magnetic or dynamic. The magnetic type uses a diaphragm that vibrates in the field of a permanent-magnet system;

this is often horse-shoe shaped as shown in the symbol. The dynamic type utilizes as a moving element a coil of wire fastened to a parchment cone; the magnetic field required for this type of reproducer or "speaker" usually is obtained from a field coil connecting to a source of direct current. This relationship of field and voice-coil windings on a common core will now be clearly understood from the symbol.

(28) The microphones in use today are of widely different types, but the carbon microphone is in quite general use. Consisting of a diaphragm on which is mounted a carbon button, the relationship is represented in this symbol as an arrow-head in contact with a block mounted on a thin line (the diaphragm); where two buttons are provided for contact to either side of the diaphragm the "double-button" symbol is used.

Representative Types of Tubes

To discourse on the complete line of tubes would only weary the reader. Suffice it to say that "tube manuals" are available for a few cents from every tube manufacturer. These manuals contain not only complete technical characteristic data concerning the entire tube line, but also in most instances considerable elementary information to assist the beginner in grasping the more essential elements of tube construction and use.

The types listed under "respective types of tubes" are merely shown as outstanding examples in the gamut of tube types.

A MAN-BACK PUBLIC ADDRESS SYSTEM

(Continued from page 543)

considerable research was necessary in order to produce a suitable amount of volume in a compact unit light enough to be carried for a considerable length of time. At the same time it was necessary to consider the life of batteries from an economy point of view. As a result this outfit uses class B amplification, employing the aircell type tubes. Inasmuch as the "B" battery voltage is fairly steady, class B amplification produces unusually good quality response. A special arrangement is provided to eliminate microphone feedback. The novel circuit arrangement is shown in Fig. 2. The input transformer couples a microphone and transformer pickup to the type 32 high gain tube. This tube is resistance-capacity coupled to the class A driver tube (a type 49) for use as a fixed bias to drive to full capacity two type 19 amplifying tubes. This hookup results in the very sufficient power output of about 4 W. produced by only 135 plate volts. Also the use of but 4 tubes results in good "A" battery economy (two No. 6 dry cells). The "B" batteries used are of the portable type universally obtained. The loudspeaker is of special design combining a high output with light weight. These man-back P.A. units have been tried in and about New York with considerable success. Passers-by are attracted by music coming from the sidewalk beside them and a sudden announcement adds to the novelty of the arrangement. The fact that the public can both hear and see (on the sign) the name of the establishment adds immediately to the advertising value. The alert Service Man will appreciate the possibilities for renting these man carried broadcast sets, perhaps to supplement an already successfully established public address business. The entire system weighs only 32 lbs. and since this is evenly divided up between the front and rear units it is possible to carry it for long periods without fatigue.

Compared to the old army packs, weighing from 50 to 60 lbs., it shouldn't be too tiring; especially when the carrier can get considerably more amusement from using it than the soldier gets from carrying his bed and board on a day's trek! Seriously, the "P.A. sandwich man" does not present the pathetic figure of his less animated predecessor, and it would seem that the system should pay well. An imaginative editor suggests incorporating a radio set in the device, and tuning the set to a local station transmitting a program suitable as "patter" for a small army of sandwich men, who would travel during intermissions to the next location, using their own "spiel" only in transit.

GET THIS BOOK AND INCREASE YOUR PROFITS

YOURS FOR 10c



● **RADIO SERVICE MEN!** This book will increase your profits, because in it you will find all of the latest technical information that is necessary for your job . . . how to recognize tube and set troubles . . . and *most important*, how to solve these problems to get fine, sure performance! The book contains 104 pages . . . and is crammed with useful information. Complete data on all tubes, including types 15, 18, 255, 25Ys, 2z2, 46B1, and 182B, and complete descriptions of over 90 types of tubes. This is Sylvania's latest service help . . . and it's yours for 10c! Take the guess out of tube application! You can if you send for this handy pocket manual.

YOURS! for 10c in STAMPS

HYGRADE SYLVANIA CORPORATION

Makers of SYLVANIA TUBES, HYGRADE LAMPS, ELECTRONIC PRODUCTS © H. S. Corp., 1935

Factories ST. MARY'S, PA., EMPORIUM, PA., SALEM, MASS., CLIFTON, N. J.



10c-TECHNICAL MANUAL-10c

Hygrade Sylvania Corporation, Emporium, Pennsylvania. (B-20)

Please send me the new Sylvania Technical Manual. I enclose 10 cents in stamps.

Name

Address

City State.....

Please Say That You Saw It in RADIO-CRAFT

HOW TO BUILD, TEST AND REPAIR RADIO SETS

Radio Construction Library

Including Television, Short-Wave Receivers and Auto Radios. 3 Volumes, 5 1/2x8—1177 pages, 561 Illustrations. This practical Library includes: PRACTICAL RADIO—The fundamental principles of radio, presented in an understandable manner. Illustrated with working diagrams. PRACTICAL RADIO CONSTRUCTION AND REPAIR—Methods of locating trouble and reception faults, and making workmanlike repairs. Discusses modern Short-Wave Receivers and installation of automobile radios fully. RADIO RECEIVING TIPS—Principles underlying the operation of all vacuum tubes and their use in reception, remote control and precision measurements. Helps you to understand modern type receiving sets—full of construction data and practical tricks for the experimenter.

10 Days' Free Examination
Easy Terms

McGraw-Hill
FREE EXAMINATION COUPON

McGraw-Hill Book Company, Inc.
330 W. 42nd St., New York.
Gentlemen—Send me the RADIO CONSTRUCTION LIBRARY, all charges prepaid, for 10 days' Free Examination. If satisfactory I will send \$1.50 in 10 days, and \$2.00 a month until \$7.50 has been paid. If not wanted I will return the books postpaid.

Name

Home Address

City and State

Position

Name of Company

RC-3-35

BUILD YOUR OWN Short Wave Receiver 5 Meter Transceiver

AS FEATURED IN JANUARY RADIO-CRAFT

ICA can supply you with just what you want through your Jobber or favorite mail order house at a discount of 40% from the list prices shown. When you buy ICA kits or parts, you are assured of quality and dependable performance.



ICA 5 METER TRANSCEIVER

A quality transceiver in 3 models: 2 volt, 6 volt or A.C. model. So easy to build! Made completely of ICA parts. Comes complete with instructions, diagrams, etc. List prices (respectively)

\$19.50, \$19.25, \$ 9.75

ICA SHORT WAVE RECEIVERS

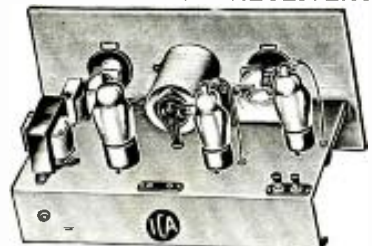

A whole line to choose from: 1 and 2 tube battery sets, and 2, 1 and 5 tube All Electric models. These are the world's easiest kits to build. Each comes complete with point-to-point diagrams. Licensed under RCA and Hazeltine patents. List prices \$9.95 and up. Write for facts before you build!

BIG NEW 1935 CATALOG

Send on receipt of 10c coin or stamps to cover cost of handling and mailing. Lists hundreds of parts, kits and accessories. Supply limited so send now to avoid disappointment.

INSULINE CORP. of AMERICA
23-25 Park Place, Dept. C-35, New York, N. Y.

A "DISTANCE-GETTER" —FOR A \$1

(Continued from page 522)

tinfoil on top of that, with a 1-in. tab projecting from one end. Then another piece of paper, and the second tinfoil "plate" with the tab projecting 1 in. from the opposite side. That's the condenser! A piece of cigar-box wood a trifle larger than the paper is tacked by the corners (don't get the tacks near the foil) over the pile. Leave that for a while and build up the phone bypass condenser the same way, using two right- and two left-hand "plates" alternating.

Now we tackle the grid-leak, which is simply a high resistance path past the condenser. A piece of cigar-box wood 1 1/2-ins. long by 1/2-in. wide is blackened on top with a soft pencil and then fastened lightly to the base with two brass-headed tacks or screws 1 in. apart. Don't tighten or drive down until connections are made—later.

A Novelty in Tube Sockets

The tube socket consists of 4 holes halfway through the base as indicated (Fig. 2B) the 2 rear ones being slightly larger than the others (3/8- and 1/16-in. will do). Contact is made to the tube prongs by means of 4 ordinary wire paper clips, bent so that the smaller part makes a spring contact with the prongs. Three of these clips are fastened to the base with washers and screws (or nails for that matter), but not driven all the way in. The fourth clip, bent as shown, is lightly secured by the washer and screw to be used as the "A—" terminal. And so we have the socket.—and a real good one, too!

And Here We Have the Tuning Condenser

The variable condenser, if carefully made, will tune easily and well. Cut a piece of tin, copper, brass or aluminum 2 1/2x4 1/2 ins. Take time to smooth it out flat, with sharp edges filed or sanded off. Punch a hole in the center of one end. Shellac that portion of the base and one side of the plate. When the shellac is thick press down firmly in the place indicated. Slip a washer over a screw, twist the end of a 2 ft. length of wire under the washer and screw tight. Cut another plate from the same material 2 3/4x4 1/2 ins. (not counting the half-inch square tab at one end). Smooth and flatten as before. Punch a hole in center of tab and screw a cork on, with the end of a piece of flexible wire (old lamp cord, or any wire not stiff) 12 ins. long under the washer. Soak a piece of cellophane 3x5 ins. in water for a few minutes; then place it on the lower plate, leaving an even margin around the edges. Press down tightly and shellac the edges to the wooden base. Guides are fastened to the base. They are simply strips of tin fastened with thumb tacks, and serve only to keep the movable plate on the right track. A piece of cigar-box wood, 1 1/2x4 ins., is screwed with two screws in the position shown. Tightening or loosening the screws serves to produce just the right tension on the movable plate.

Winding the Coil

Now we tackle the three-circuit tuning coil, and again it is easy if we take it one step at a time. Get a cardboard tube 2 1/2 ins. in diameter (baking powder, coffee, salt carton) and cut with a razor blade to 4 ins. in height. Begin 1/4-in. from one end and wind on 30 turns of No. 28 insulated wire (cotton, silk or enamel). Bring the ends down through pinholes in the tube. Put little tickets on each lead indicating which is which, so that when the coil is mounted you will have no difficulty with wrong connections. Next leave a gap of 1/4-in. and wind on 60 more turns. Don't break the wire here, but leave a 3/16-in. gap and continue for 30 more turns. Bring the ends down inside the tube to the same end as the primary coil and mark for identification. Punch holes in opposite sides of the tube in the center of the 3/16-in. gap to admit a piece of stiff wire used as a shaft for the "tickler" or feed-back coil. This coil is wound on a 2 in. tube 1 1/4 ins. high. (Cut a 1-in. piece out of a section of the 2 1/2 in. tube, overlap 1/4-in. and glue or tie in place, or use a 2-in. tube if available.) Wind 20 turns on each side of the center, leaving 1/8-in. gap for the stiff wire shaft. If flexible "cord" is handy, attach 1 ft. pieces to each

end of coil. Otherwise just leave ends that long. Now straighten out a 5-in. piece of stiff wire (a package handle wire is fine) and push it through the hole in the outside coil. Now a washer; punch through both sides of the tickler at the center gap, another washer, and the back side of coil, projecting 1/4-in. Sealing wax on the shaft and inner surface of the tickler will secure both very nicely. Shellac all coils (although not really essential).

Now mount the coil in any way you like, so long as it is upright, with the tickler near the top. Bring the 4 leads out at different parts of the bottom of the tube to eliminate any possibility of short circuits. The tickler leads come out at the top.

The shield in front of the coil is a square piece of any metal available, with bent-over feet at the bottom and a hole punched to pass the tickler shaft. At this point you can make the first complete connection. Bring the top end of the antenna coil (L1) to one foot of the shield, scrape off the insulation and secure under foot, bringing the end back to post "G" (ground). The shield should be 1/4-in. from the side of the coil. Drive a cork on the wire shaft, pushing it far enough to spring the shield toward the coil slightly. This provides friction, necessary to make the tickler stay where you turn it.

Connecting It Up

One other item and we are ready to wire the set. Wind 36 ft. of No. 36 insulated wire on a thread spool, securing the ends in slits cut in spool end, and leaving 6 ins. free at each end. This is the filament resistor, to reduce the 3 V. dry battery to 2 V. for the 30 tube filament. A long screw or nail holds the spool upright on the base just to the right of the tube socket. See Fig. 2c.

Now for the wiring. If you have left the proper lengths as instructed it will be easy, and no solder need be used if you don't have it. Run the bottom lead of L1 to post "A" (aerial). The bottom lead of L2 (grid coil) goes to one tab of the grid condenser and one end of grid-leak, along with one lead from the variable condenser. Roll the foil around the wires and press them tightly together. The top of L2 goes to post "A+", where the other variable condenser lead joins it. (All "posts" are just plain wood screws with washers.) One lead from the tickler (L3) goes to one phone post and to one tab of the bypass condenser. The other end of L3 goes to the tube plate clip. One end of the spool wire connects to "A+." Run a wire from the "B—" post to the other end of the bypass condenser and then to "A—" (which holds one socket clip.) The grid clip of the tube socket goes to the grid condenser and grid-leak. The remaining end of the spool wire goes to the remaining clip, "A+", of the socket. The last wire connects post "B+" to the remaining phone post.

How to Operate It

Connect two dry cells in series (that is, with the "+" or center post connected with a wire to the "-" or side post of the second cell) to posts marked "A+" and "A—" (the center connection of a dry cell is positive). Connect the phone and 45 V. "B" battery to their respective screw posts and plug in the tube. Now all you have to do is turn the tickler slowly and move the condenser at the same time. There is a slight click when tickler coil goes into "oscillation." This is the most sensitive setting. A little practice will enable you to tune easily. Use a pencil eraser to erase part of the grid-leak, a little at a time, until the tickler works smoothly and programs are loudest. And there you are! Good luck!

Fig. 2

Showing shape and dimensions of fixed condenser plates at A, unique socket at B, and tube filament resistor at C.

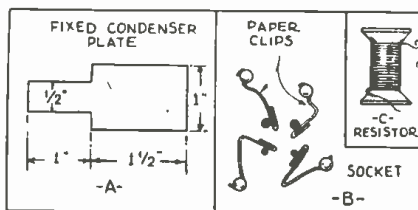

Please Say That You Saw It in RADIO-CRAFT

SEND FOR THIS
FREE CATALOG

Check full of BARGAINS in RADIO SETS, Lamp and Short Wave Apparatus, Servicemen's Repair and Replacement Parts, Electrical Appliances and hundreds of miscellaneous specialties at **THUNDEROUS SAVINGS.** Get this big new Bargain Book. It's absolutely FREE without obligation—just send us your Name and Address on a post card. **WRITE FOR YOUR COPY NOW.**

JUST OFF THE PRESS

RADIO CIRCULAR CO., INC.
225 RC VARICK ST., NEW YORK

Introducing a **NEW** Ribbon "MIKE"

Improved in Style As Well As Quality

High-frequency characteristics—substantially flat from 50 to 10,000 cycles. Ruggedly constructed—not affected by humidity or mechanical shocks and free from background noise—directional pick-up characteristics. This ideal heat-type velocity "mike" is supplied with matching transformers for 500 or 500 ohm transmission lines, and 6 ft. shielded cable.

MODEL "Bruno" Dealers Price \$15.00

ORDER DIRECT OR FROM YOUR JOBBER
LABORATORIES 24 West 22nd St. New York, N. Y.

Ken-Rad Radio Tubes
DEPENDABLE LONG LIFE

Ken-Rad Radio Tubes are made to give clear, dependable reception. They satisfy customers and build good will for dealers. Write for full information.

THE KEN-RAD CORP., Inc., Owensboro, Ky.
Division of The Ken-Rad Tube and Lamp Corp.
Also Mfrs. of Ken-Rad Incandescent Electric Lamps

WHEN CHOOSING A RADIO SCHOOL

RCA Institutes, with its reputation established by 25 years service, is an institution recognized as an important factor in the radio industry. Whether elementary radio principles or advanced subjects, sound applications or practical radio engineering, RCA Institutes is prepared to give you the instruction you need.

RESIDENT SCHOOLS NEW YORK AND CHICAGO with modern standard equipment
EXTENSION COURSES FOR HOME STUDY under convenient "no obligation" plan. Illustrated Catalog on Request.

R. C. A. INSTITUTES, Inc. Dept. RT-35
75 Varick St., New York—1154 Merchandise Mart, Chicago

AGENTS WANTED!
MOTION PICTURE SOUND

Most fascinating field awaits live Radio Service Men—quick, sure profits
ASK FOR FREE CATALOGS
S.O.S. CORPORATION
1600 Broadway New York, N. Y.
Cable Address: "Sosound" New York

A PRE-AMPLIFIER FOR THE S.-W. RECEIVER

(Continued from page 545)

3. Rejection of image or repeat spots (in superheterodyne sets).
4. Considerable increase in selectivity.
5. Reduction of noise-to-signal ratio.

Regeneration Used

This particular unit comprises two tuned stages. Now with the same number of stages, if we could increase its effectiveness to the extent of another one or two stages, making the overall pre-selector an equivalent of three or four stages, then we will have literally raised our receiver far above its class. This can be accomplished by the proper use of regeneration.

The unit utilizes two tuned stages of high gain type 58 tubes, the first stage being electron coupled regenerative. Electron coupling lends greatly to stability in operation. The regeneration control is, of course, variable to obtain maximum gain.

This control, if advanced past the point of maximum regeneration, will allow the first stage to oscillate: it is used at the point just before oscillation occurs, never in the oscillatory position. The gain is very high at the point of maximum regeneration, but falls off after oscillation sets in.

The tuning unit is the popular illuminated airplane type dial with black background and white graduations and pointer. The escutcheon is oxidized silver. The regeneration control is the lower left-hand knob. The center control is the change-over switch. On the right is the double-pole, double-throw, on-off switch. This latter switch in the off position throws the aerial from the pre-selector to the receiver proper. The unit contains its own filament supply and it is only necessary to tap the positive plate supply from the receiver with which it is used for operation. The "B plus" may be obtained from any point at the filtered side of the plate supply. The negative connection can be obtained from the chassis or ground terminal on the receiver. Any "B" voltage between 150 and 300 volts may be used. Of course, a separate plate supply may be used but it is not necessary.

The unit is contained in a heavy gauge steel black-crackle finished cabinet 7 1/2 x 9 1/4 x 10 inches. It covers all wavelengths with ample overlap from 14 to 200 meters with three sets of built-in coils, thus doing away with the undesirable "plug-in" method. The obvious convenience of this switching system brings itself to the fore when one is DX-ing over a wide range of frequencies.

A view of the pre-amplifier, showing arrangement of the few parts and their relation to each other.

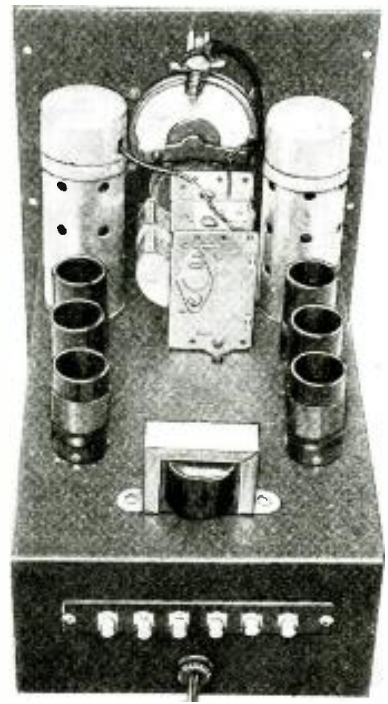

A SIMPLE, INEXPENSIVE WAY TO BRING MOST ANALYZERS up to date

The **WESTON Model 666 Type 1A SOCKET SELECTOR SET**

There's no need for you to be handicapped with an analyzer incapable of analyzing all of today's radio receivers. A small expenditure will bring it out of the obsolete class.

Weston makes it possible through the improved Weston Socket Selector Set which is readily adapted to any and all analyzers. Simply attach the Socket Selector Unit to the analyzer... and by use of the colored adapter combinations you are set for all present day 4-5-6- and 7-prong tube receivers.

It's a simple, inexpensive way for you to broaden the scope of your present analyzer. Although, nothing you can do with an old analyzer can ever give you the dependability and profit-producing service that the new Weston models illustrated can give. A bulletin describes all. Send for copy... Weston Electrical Instrument Corp., 599 Frelinghuysen Ave., Newark, N. J.



Model 665 SELECTIVE ANALYZER
— available with rotary switch for selection of ranges—or, with pin jacks, in a lower cost model.



Model 698 SELECTIVE SET SERVICER
— a modern Weston set servicer at extremely low cost. The outstanding value in test equipment.

WESTON Radio Instruments

WESTON ELECTRICAL INSTRUMENT CORPORATION
599 Frelinghuysen Avenue, Newark, N. J.
Send bulletin on Weston Radio Instruments.

Name _____
Address _____
City and State _____

Please Say That You Saw It in RADIO-CRAFT

Train Now for New RADIO Opportunities



Get Into a Line Where There's Action—Every Day—And a Payday Every Week—You Be the Boss!

Analyzer & Resistance Tester—Latest Design—YOURS Without Extra Cost

Right now while hundreds are looking for work where there isn't any, the radio service field can use trained men. With the proper training and the necessary equipment, you can enter this field and make a comfortable living. We include with our course this modern set analyzer and trouble shooter without any extra charge. This piece of equipment has proved to be a valuable help to our members. After a brief period of training, you can take the set analyzer out on service calls and really connect with "old timers." We show you how to wire short-wave receivers—analyze and repair all types of radio sets—and many other profitable jobs can be yours. Teaching you this interesting work is our business, and we have provided ourselves with every facility to help you learn quickly yet thoroughly. If you possess average intelligence and the desire to make real progress on your own merits, you will be interested.

ACT NOW—MAIL COUPON

Start this very minute! Send for full details of our plan and free booklet that explains how easily you can now cash in on radio quickly. Don't put it off! Write today. SEND NOW!

RADIO TRAINING ASSN. of AMERICA
Dept. RC-53, 4513 Ravenswood Ave., Chicago, Ill.
Gentlemen: Send me details of your Enrollment Plan and information on how to learn to make real money in radio quick.

Name.....
Address.....
City..... State.....

A REAL QUALITY Amplifier THAT'S A KNOCKOUT

As Featured in February Radio-Craft



4 STAGES
30 WATTS

This remarkable high fidelity Class "A" Prime P.A. Amplifier employs tubes of exceptionally low in cost, and yet it delivers an output of 30 watts. The Marlo Amplifier contains so many of the finer characteristics usually found only in most expensive equipment. It features stepless tone control, variable hum-buster filter, high safety factor, full-range volume control and separate mixer-coil outlet. The frequency range at the rated maximum power output, with a harmonic content not exceeding 7% and a power variation not exceeding 4 db. ±, is about 50 to 12,000 cycles. The circuit of this highly efficient Marlo Amplifier has been developed by proficient sound engineers—it is designed to operate on 105-125 volts A.C. giving perfect performance under all conditions. Its chassis is of rugged auto-body steel—finished in a beautiful black crackle crystal-like effect. Tubes used in the circuit are: 1-57; 1-86; 1-8AB; 4-45; and 1-5Z5.

AMPLIFIER—completely assembled, wired and tested, less tubes. \$22.50 NET

Special equipment available at lowest possible prices. Complete details sent immediately on request. MARLO PRODUCTS CO. 16 Hudson St. New York, N. Y.

WET AND DRY ELECTROLYTIC PAPER AND MICA CONDENSERS

RECOGNIZED FOR SUPERIOR QUALITY IN ALL CLIMATES THE WORLD OVER

SOLD BY LEADING JOBBERS EVERYWHERE

SOLAR MFG. CORP. 399 BROADWAY NEW YORK

BEST BY TEST!

ASK FOR CATALOG OF EXTREMELY COMPACT TYPES HANDY FOR SERVICE

RADIO MONTH IN REVIEW

(Continued from page 519)

means a complete thought in a conventional language thereby making it possible to state a 150-word English announcement in eight words of the "radio" language.

This new tongue has been sponsored by radio station WBNX in New York and, since its inauguration last month, has created considerable comment among radio listeners who heard it.

A study of the language is unnecessary it was explained by officials of the station, as code dictionaries will be supplied to listeners. Less time is encountered in using these dictionaries than using any standard lexicography and they can be eliminated after one familiarizes himself with the symbols.

A number of amusing inquiries were received from listeners who heard the first broadcasts and were unaware of the tests being made. One of the inquiries made by telephone after several minutes of the radio language during which loudspeakers emitted such sounds as SODO, SOFA SOSO came from a man in Newark who asked crisply, "So what?"

Among the numerous messages transmitted was RE SIDOSI, which it was explained meant "Station WBNX in New York sends its greetings for a joyous Christmas and a Happy New Year replete with happiness and prosperity to all." My what a saving of words!

FAMOUS I-TUBE CIRCUITS

(Continued from page 528)

sheet," the necessary "B" battery exists in the circuit and is found hiding as part of the "A" supply. Correct balance between control-grid and plate voltages is obtained by adjustment of potentiometer R2. Do not exceed the rated filament voltage of the tube.

OSCILLODYNE. While this circuit is not an old-timer, being less than two years old, it deserves to be classed among "Famous Circuits." It is a regenerative circuit, unique in that the feedback is very much greater than that required to produce oscillation. Feedback is too great to allow the electrons on the grid to leak off sufficiently fast to maintain a constant grid potential. The varying grid potential produces a corresponding variation in the plate current, with high amplification. Grid-leak, condenser and tickler coil values are of extreme importance in getting this result.

As will be noted in the schematic diagram, the tickler coil contains as many as, or more turns than the grid coil. The grid condenser is very small (only 50 or 100 mmf.) and a 3 meg. grid leak is used. These values permit variations in the grid potential, instead of the constant potential usually found.

The Oscillodyne—a circuit of the super-regenerative type. Less than two years old, but interesting to the experimenter.

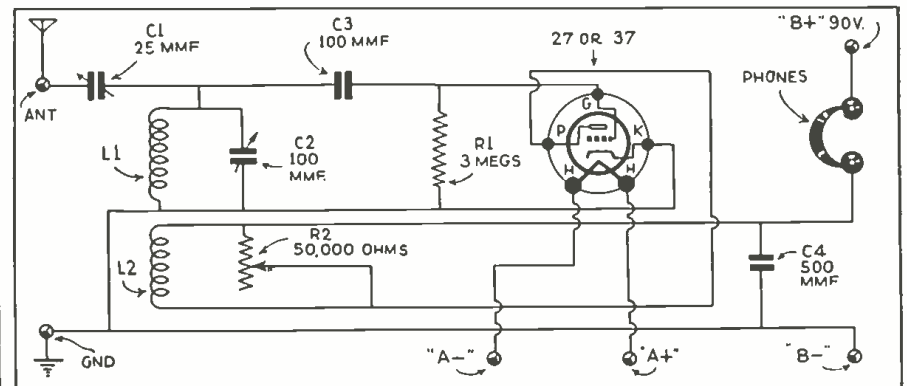

"OPERATING NOTES" READER'S COMMENT

Editor, RADIO-CRAFT:

I note the publication of some of my service notes in the Operating Notes department of the last two issues of RADIO-CRAFT, for which I thank you very much. I have also noted several errors to which I am calling your attention, in this letter.

On page 373 of the December issue the note under the heading "Philo-Early 90 and 20" I note the name of C. S. Britton, instead of my own.

On page 352 of the December issue the illustration of hookups given as Fig. 6 are all in connection with my notes, hookup B, being the bias hookup of a Lyric model S-8, and hookup C being that of an old-type 8-tube Lyric having a 250 power tube. The notes in connection with the B and C hookups mentioned above have not been printed.

On page 447 of the January, 1935 issue, my note under the heading "Victor R-32" has no name below it.

I presume that most of these errors are printer's and that you have the correct "dope" on file, in case you haven't however I am writing you these corrections. If you will look up my original manuscript you will find that I am correct, for I have checked over my service notes, from which the manuscript was written. I note that at the top of the page of Operating Notes you state that upon publication the notes will be paid for at regular space rates, and for this reason I am sending you these corrections.

Hoping that you will accept these small corrections in the spirit in which they are meant, and that you may see fit to publish other of my notes in the future, I remain

Robert C. Hannum,
512 Hannibal Street,
Fulton, N. Y.

We deeply regret the peculiar circumstance that caused the error which Mr. Hannum has brought to our attention. Some of the "Notes" in question were "over run" from a preceding issue, and in "pulling proofs" of this over run the items became shuffled in such way as to result in erroneous credits.

"I-TUBE SUPERHET"

We regret that the 1-tube superheterodyne receiver article announced for publication in this issue of RADIO-CRAFT was not available in time for the issue. However, it is expected that experiments on this novel radio set will have been completed in time for publication of the article in the forthcoming issue. Your indulgence is appreciated.

RADIO-CRAFT INDEX

By Subjects, Issues and Authors, the July 1929 to June 1932 issues of RADIO-Craft are indexed and cross-indexed, in a publication you may obtain for only 25c (stamps or cash).

RADIO DEBUNKED

(Continued from page 531)

ment in tone perfection. Other models, with four or more tubes, made to order at, of course, added cost, come in exquisitely colored aluminum, plated and sterling silver, or even jewel-studded solid gold. In vivid modernized colors, too, or in the raw. But also an ultra-gift model, its cabinet finish a sleek, rich Black Diamond, encrusted with silver chrome. It is acclaimed the gem of the decorator's art. Specially encased in gift boxes which, when unpacked, transform themselves into handsome paper baskets. The B..... Radio, distinguished companion of the big expensive radio sets, reposes proudly in the homes and offices of America's business leaders, in the studios of eminent artists and musicians, exclusive clubs and colleges, on pretentious yachts, steamships, and elsewhere in the fashionable places and palaces of the world.—and all this for only \$15.00 complete with tubes! Imagine the rhetoric, had the set listed for \$25.00! The mere thought staggers our comprehension!!

The sooner the radio industry is rid of such practices the better it will be for all concerned—the manufacturer, wholesaler, dealer, buyer and in fact the entire industry.

The Inside Facts

This leads to the subject of selectivity as claimed by various set advertisers—of course every set is "razor sharp" or has "knife edge" selectivity, but this means as little as some of the perfect selectivity curves which the writer has been privileged (?) to see. If these curves could be believed, and the manufacturer obviously expects the consumer to believe in their integrity, there can be absolutely no improvement made in radio receivers, at least from the viewpoint of selectivity.

Unfortunately, however, these supposed selectivity curves are far from accurate and are quite deceiving to the prospective set buyer. In a group of sets tested by the writer with a laboratory set-up, only 40 per cent came anywhere near to checking with the published selectivity curves and of this number only a mere handful were within 5 per cent of the published curves.

Quite a number of sets are now equipped with gadgets which are politely called "tone controls"—the ads being so worded that the prospective buyer is led to believe that by simply turning a knob you can adjust the balance of bass and treble to suit your taste or the acoustic conditions of the room. In a very few cases (those in which more than one control or knob is used) the tone control does actually change the proportion of high- and low-tone output. A great majority of the so-called tone controls, however, are simple devices for removing what high-frequency reproduction there is!

Of course, any talk about adjusting the balance of bass and treble to suit the particular music is so much bunk as all modern broadcast stations, especially those in the "hi-fidelity" class send out music correctly and if the receiver is really giving the faithful reproduction claimed for it, we can only spoil this by altering the tone control. The only excuse at all for a tone control, and even here the need is questionable, is to compensate for high- or low-frequency absorption caused by furniture, drapes, etc., in the room.

But I have come to the end of the allotted space and the debunking is only half done. I think, though that everyone will agree that a little cleaning up of radio claims would do a lot of good.

TOLEDO SOUND EQUIP. LABS. (NEE "BUD")

Toledo Sound Equipment Laboratories is the new corporate name under which the manufacturing organization formerly known as Bud Speaker Company, of Toledo, Ohio, will henceforth operate.

The new firm name is more in harmony with the greatly expanded operation of the Company and the larger and more versatile line of sound equipment now being manufactured and distributed by it.

The Company has recently moved into new larger quarters, added much new equipment and numerous new items to the line. The officers and executive personnel remains unchanged.

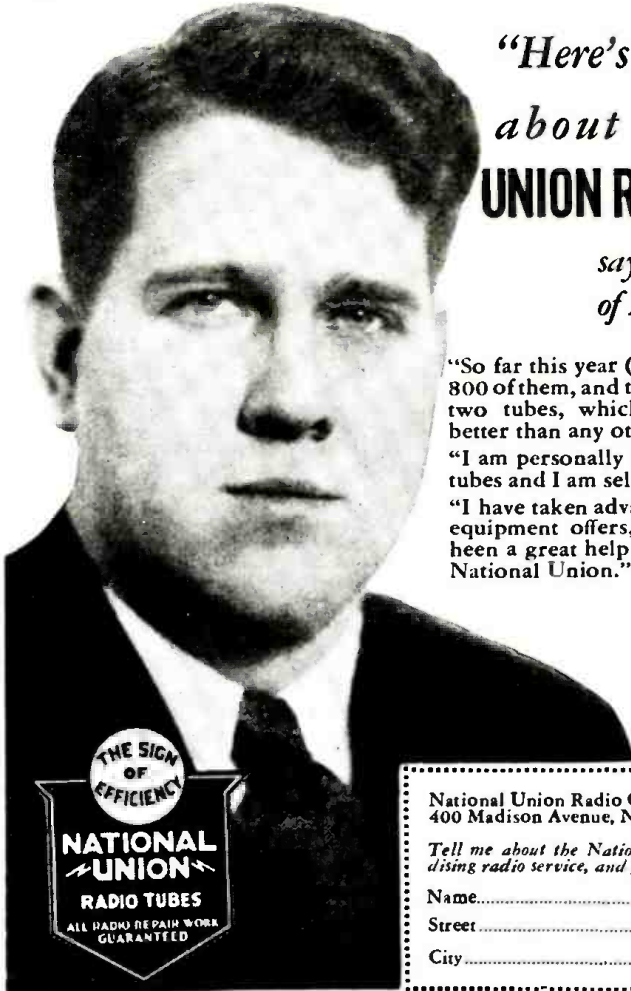

"Here's what I think
about **NATIONAL
UNION RADIO TUBES**"

says **Fred D. Kerridge**
of **Minneapolis, Minn.**

"So far this year (1934), I have used about 800 of them, and to date, have replaced only two tubes, which is about 400 percent better than any other tube I have ever used.

"I am personally SOLD on National Union tubes and I am selling only National Union.

"I have taken advantage of five of your shop equipment offers, and they have certainly been a great help in my work . . . thanks to National Union."

Thousands of alert aggressive Service Dealers have joined the National Union plan for better service business. Why not you?

SEND COUPON TODAY



National Union Radio Corp. of N. Y.
400 Madison Avenue, New York City

RC-335



Tell me about the National Union plan for merchandising radio service, and free shop equipment.

Name.....

Street.....

City..... State.....

USERS Say:

"THEY'RE GREAT!"

WHEN leading experimenters say they get more stations, louder signals and sharper tuning with these low-priced Hammarlund Coils than with any other coils, at any price, you know they're **RIGHT!** **RIGHT in performance—RIGHT in price.**

Four-coil Set (2 windings, 15-270 meters), \$3.00. Four-coil Set (3 windings, 15-270 meters), \$3.75. 40% discount to experimenters.

Hammarlund Coil Forms are ribbed for air-spacing, have easy-grip flanges and "Meter-Index" inserts. Molded from "XP-53," the sensational new low-loss dielectric, without artificial coloring. 4 or 5 prongs, 35c each. 6 prongs, 40c each. 40% discount to experimenters.

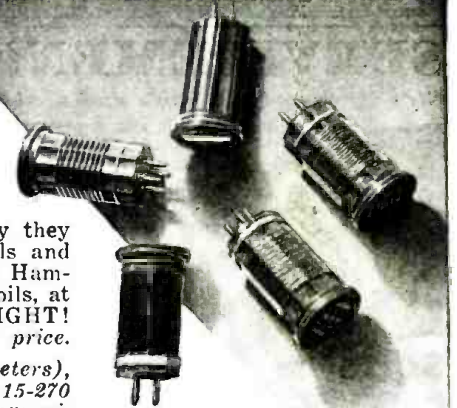

Low-Loss

**COIL FORMS
and COIL SETS**

"STAR" MIDGET CONDENSER Ideal for Short-Wave Beginners

Exceptional in quality and low in price. Six types, including single and double-spaced, for receiving and transmitting—tuning, balancing, trimming, etc. 85c to \$1.25 each, less 40% to experimenters.



HAMMARLUND MANUFACTURING CO.
424-438 W. 33rd St., New York, N. Y.

Check here and attach 10c for 1935 S-W Manual of 12 most popular circuits. Check here for FREE 1935 General Catalog.

Name.....

Address.....

RC-3



Please Say That You Saw It in RADIO-CRAFT

PORTABLE SOUND SYSTEMS
ELECTRO DYNAMIC UNITS
CARBON MICROPHONES
AMPLIFIERS
4, 5 & 6 FT. ALL ALUMINUM TRUMPETS
FIELD EXCITERS
AIR COLUMN HORNS
LOW AND HIGH FREQUENCY UNITS FOR WIDE RANGE THEATRE USE



ACCEPT OUR
5 Day
FREE
TRIAL

You can try any Toledo P.A. Equipment you need 5 days under any and all conditions absolutely without cost or obligation. Accept this challenge to duplicate Toledo's amazing performance and absolute dependability at any price. Write for folder giving complete details of free trial offer, prices and descriptions of Toledo's sensational, advanced 1935 equipment.

TOLEDO SOUND EQUIPMENT LABORATORIES
 Formerly Bud Speaker Co.
 1146 JACKSON STREET • TOLEDO, OHIO, U.S.A.

HOW TO GET STARTED IN P.A. WORK

(Continued from page 541)

sale requirements.

As it is, the fundamental purpose of P.A. systems is to reinforce sound—and as most of them do this—amplifiers in particular should no longer be bought entirely from this standpoint—we should consider details of versatility, adaptability, simplicity of installation, and economy of operation. With modern advances in engineering design we should expect more of an amplifier than merely "Will it amplify?"

High Fidelity Reproduction

An ideal high-fidelity sound system must be free from frequency, amplitude, and phase distortion. It must be uniformly responsive over the entire audible range between 30 and 16,000 cycles. With this in mind, Engineers have perfected an amplifier (Fig. A) to such a degree that its overall performance is limited only by the frequency response characteristics of the associated equipment (microphone, speaker, radio tuner, or phono-pickup) used with it.

Inasmuch as different P.A. installations, rentals and applications usually require different amplifiers—for either 6 Volt D.C. or 110 Volt A.C. operation—for high and low power output—for indoor, outdoor, mobile, and portable work—for ribbon, crystal, dynamic, condenser, inductor, and carbon microphones—for high or low gain—for radio and phono pickup, it is best to select one amplifier that is suitable for all applications and all methods of operation. The amplifier illustrated in Fig. A is typical of such a system.

A casual study of Fig. 1 will disclose the ingenious circuit used in the construction of the amplifier which combines onto one chassis a three-position mixer, a high-gain pre-amplifier, voltage amplifier, phase inverter, a high- and low-power amplifier and an 110 volt A.C. power pack as well as a 6 V., D. C. power supply.

Economical operation at high powers is attained by using a carefully designed class B audio output system composed of two channels each delivering 12.5 watts. The dual channel switch cuts the extra channel in or out of the circuit (opens the filament and plate circuits of the second channel) without affecting the impedance relationship of speaker or speakers connected to each of the universal output transformers.

With this arrangement it becomes a simple matter to economically keep within desired power limits when it is being powered by a 6 V. storage battery or commercial power line.

When both channels are operating at the same time, full 25 W. is easily attained with less than 5 per cent harmonic distortion (unnoticeable to the ear). This audio power if used with efficient speakers is sufficient to "flood" 20,000 to 30,000 square feet of outdoor area, or 8,000 to 15,000 people in indoor gatherings.

To change from 6 V. storage battery operation to 110 V., A.C. or vice versa, it is only necessary to set the A.C.-D.C. switch to the desired position—no adapters required—no tubes to change—no plug or cable arrangements are necessary. The great advantage offered by this system is that it enables you to operate the same amplifier in your auto and then, for demonstration purposes, take it indoors and operate it directly from the 110 V. power socket.

A close examination of the A.C.-D.C. switch will reveal how utterly foolproof the arrangement actually is. The amplifier system cannot be damaged even though both the storage battery and the power line are connected to it, for only one of these power supplies can be used at a time!

The overall gain of an amplifier is of vital importance, particularly when it is unwise to confine the operation of the entire system to the use of carbon microphones.

As the use of ribbon (velocity), crystal, dynamic, inductor, and condenser microphones are becoming more and more popular and afford better frequency responses characteristics than carbon microphones, it is essential that a high-gain pre-amplifier be incorporated into the system so that the purchase of additional equipment will not be necessitated if and when ribbon or crystal microphones are to be used. Fig. 1 shows how the first tube acts as a high-gain pre-amplifier.

This new and approved use of the 6A6 as a 2-stage resistance coupled amplifier provides a voltage amplification gain of 720 which brings the level of the weakest input device up to the average output of a carbon microphone without introducing any hum into the input circuit. Of course, this additional 2-stage amplifier is not required with carbon microphones or magnetic phono-pickups and is therefore shunted out of the amplifier circuit by the 3-5 stage selection switch. It can thus be seen that no matter what kind of an input device is used with the amplifier, there is more than sufficient gain (130 db. at 1,000 cycles with five stages) to obtain full power output with a ribbon microphone without any additional pre-amplification.

The self-contained 3-position mixer provides for the mixing, blending, and fading of any one or more signals into the other for use as background or special sound effects. Of course, the mixer circuit is an optional feature and may be omitted (if only speech amplification is required) or, it may be altered to accommodate two or more microphones, phono-pickups, etc.

Selection of the Microphone

While it is easy enough to design an amplifier for a wide variety of applications, such is not the case with microphones. In fact, the particular advantages and disadvantages of each type of microphone makes it rather difficult to recommend any one of the six most popular types, (carbon, crystal, dynamic, inductor, condenser, velocity (ribbon)) for all possible applications.

As the amplifier will operate satisfactorily

SERVICEMEN!

Step Ahead of the rank and file—



with "CASE RECORDS OF BROADCAST RECEIVER REPAIRS"

- ADD 10,000 Hours to your experience!
- ELIMINATE GUESSWORK IN YOUR SERVICING!
- DON'T PUZZLE YOUR PROFITS AWAY!

Your work is already done and recorded for you in "CASE RECORDS". This 9x12" loose-leaf binder contains 1,500 alphabetically and numerically arranged "CASE RECORDS" of "SUCCESSFULLY COMPLETED SERVICE JOBS!"

\$4.75

Each CASE RECORD tells all details for satisfactory repair. SUPPLEMENTED QUARTERLY FREE for 1 year. 108 receiver makes . . . 3,000 models.

. . . the FASTEST Technique known to the Profession!

First Supplement NOW READY!

Send cash now and receive 1st Supplement with "CASE RECORDS" and our DATA SHEET on "BUILDING AN ANALYZER ADAPTER" also.

Refund on return of Manual within 10 days.

CAPITOL RADIO RESEARCH LABORATORIES, INC.
 1503 21st Street, N.W., H. K. Bradford, President
 Washington, D.C.

REPLACEMENT PARTS
FOR ALL RECEIVERS

8 mfd. 500 v. cardboard electrolytics, per dozen \$3.00
 Sprague Beeswax dip condenser 200 to 500 volt working 1 to 5 mfd., special assortment 1.00
 100 for 1.00
 110 grade 1 watt resistors, 1/2w for 1.00
 3 1/2 watt amplifier 110 v. 60 cycle wired 4.95

Uncle Dave's Radio Shack,
 356 Broadway, Albany, N. Y.

By Subjects, Issues and Authors, the July 1929 to June 1932 issues of RADIO-CRAFT are indexed and cross-indexed, in a publication you may obtain for only 25c (stamps or cash). Write to us for this valuable 24 page reference; its use will save you time and money!

Here is a rather elaborate example of a P.A. trailer—in which a complete medium power P. A. system is installed. This particular installation contains a well fitted "studio." It is interesting to note that the reproducers are installed in the "head-lights" on the top of the trailer. These reproducers can be rotated to take advantage of the directional effect.

Photo—Wright-Deoster, Inc.



Please Say That You Saw It in RADIO-CRAFT



One of the
SUPREME FIDELITY AMPLIFIERS
6 VOLT
AUTOMOBILE
AMPLIFIER
\$37.50
less tubes

Triple Push-pull; Built-in Generator; Tapped Inputs and Outputs for mike, phono and speakers; Mike Current Supply; Mike-Phono Input Switch; No External transformers necessary

Send for a copy of our Public Address Sales Manual and General Catalog



WHOLESALE MERCHANDISERS, Inc.
626 Bway., Dept. C, New York, N.Y.

LEARN RADIO

200 Graduates Placed in the Last Three years
At the oldest, largest and best equipped privately owned radio operating school in the East. Western Electric and RCA tube transmitters; 200 licensed graduates placed in past three years in broadcasting, shipping, police radio, aviation, service work, etc. Course prepares for all U.S. Government Telegraph and Telephone licenses. Send for 40-page catalog. Investigate. New classes every six weeks from Sept. 10th. Open all year around.
MASS. RADIO SCHOOL, 18 Boylston St., BOSTON
R. F. Trop, Treas.—EST. 1899—G. R. Entwistle, Pres.
One of America's leading Radio Schools

THE ALL-ELECTRIC ALL-WAVE RECEIVER

A completely electrified SW receiver capable of wide-band reception. Uses special circuit for 6F7 (2 tubes in 1 bulb), 37, and 12X3 tubes resulting in 1 tube performance. Operates entirely on 110 volt ac or dc house lighting system. Coils for 10-200 meters and instructions included.
Foreign Reception Guaranteed.
KIT.....\$5.95 Wired, extra.....\$1.25
Broadcast coils.....\$0.95 Areturus tubes.....2.25
C.O.D. ORDERS FILLED. PROMPT SHIPMENT
EILEN RADIO LABS., Dept. RC3
463 Fourth Ave. New York, N. Y.

RUN YOUR A.C. RADIO BY DIRECT CURRENT

Operates AC Radios, amplifiers, transmitters, etc. From 6.32 or 110 D.C. Sent on trial.
KATO ENGINEERING CO.
Mankato Minn. U. S. A.
AC generator \$16.00. Light plants \$99.00.

STOP GUESSING!

Radio service is easy when you know just where to look for the trouble. A CHUCKER troubleshooter and repair-pricer eliminates guess-work in what is wrong and what to charge. Used by progressive servicemen everywhere. Price \$1.00 postpaid.
FREED'S RADIO CO.
Publishing Division R
5053 Baltimore Ave., Philadelphia, Pa.

New CRYSTAL MICROPHONES

Now at Your Jobber (Licensed Under "Brush" Patents)
SHURE BROTHERS COMPANY
Microphone Headquarters
215 WEST HURON ST. CHICAGO, U. S. A.

NEW ANGLE VISE HAS NO EQUAL Only \$5.95

A new invention—at the lowest price in the field. The Patented Angle Vise accurately graduated in degrees—for all production, tool and general shop use, saves hours in welding and setting angle plates, making dies and fixtures. Makes it possible to cut, drill or grind at any angle by means of one quick, simple adjustment. Has greater strength and holding capacity than ordinary vises. Weights 2 1/2, 4, 6, 8, 10, 12, 15, 20, 25, 30, 40, 50, 60, 75, 100 lbs. Construction guaranteed. SPECIAL LIMITED OFFER. Price—only \$5.95 plus postage. Order \$2.00. Pay postman or extra-man balance due. Send at once.
Chicago Tool & Engineering Co., Dept. M-83945, Chicago Av., Chicago, Ill.

ALUMINUM PANELS

16 Gauge.....7x12, 28c; 7x14, 32c
5/64 Inch or 13 Gauge.....7x10, 29c
7x12, 34c; 7x14, 41c; 7x18, 49c; 7x24, 68c
These panels are a special lot at the above prices. Larger and odder at correspondingly low prices. Add postage on 2 lbs. for each. We do not publish a catalogue. Estimates gladly furnished on request.
Radio parts for over 10 years.
BLAN THE RADIO MAN, Inc.
177 Greenwich St. Dept. RC New York, N. Y.

Patronize RADIO-CRAFT advertisers for merchandise of value.

with any one or all of the microphones, it becomes necessary for the purchaser to select one or more, depending upon the intended applications of the system. The following points should be kept in mind when selecting a microphone:

1. Cost
2. Local acoustic conditions
3. Ruggedness
4. Frequency response characteristics
5. Sensitivity

Carbon microphones are the cheapest, but require the most attention and care. They cannot be operated while in motion and introduce background noise or "hiss."

Most troublesome local acoustic conditions are rectified by using directional microphones—ribbon (velocity), dynamic, or damped crystal microphones.

Ruggedness depends more upon the individual construction of the microphone than upon its type. With the exception of the carbon type, all others are mechanically shockproof. A well constructed ribbon or dynamic microphone can probably take the most punishment.

Outside of the expensive multi-cell crystal microphone, a good ribbon velocity microphone leads all others in uniform frequency response.

Sensitivity is merely a matter of damping. Any of the various types can be damped more or less. Highly damped microphones are best for outdoor work to prevent extraneous noises from being picked up and amplified by the P.A. system. These microphones also avoid audio feed-back when the microphone is operated close to the speaker.

Undamped microphones are best for indoor work, particularly when the original sound or sounds are to be picked up over a great area with the minimum number of microphones.

For best results in any type of installation, it is recommended that at least one ribbon, crystal, and carbon microphone be on hand to meet any kind of an emergency. A number of difficult installations have been successfully solved by using two different types of microphones at the same time.

Selection of the Pickup and Turn-Table

For all around purposes it is best to use a phono motor and pickup that is capable of playing both the 33 1/2 and 78 R.P.M. records. While an automatic record changer is not essential, it is a great help to the lone operator who is forced to change the record while driving.

If the entire system is to be universally operated it is essential that the motor be designed to operate from both 110 V. A.C. and 6 V. D.C. This is accomplished by using a 6 V. A.C.-D.C. motor and a suitable 6 V. step down transformer for 110 V. A.C. operation.

Selection of the Speaker

All of the audio power developed by the amplifier must now be reconverted into sound waves in order to be of any use. While the speaker represents the last link in the P. A. chain its function is of vital importance, and under no conditions should any handicap be imposed upon the sound system by the selection of an inadequate loudspeaker system.

Two of the most popular type speakers used in sound cars are dynamic (moving coil) speakers, and dynamic horn units and trumpets. The exact type to use depends upon the kind of P. A. work you expect to do. For high quality reproduction of music and speech where volume is not of paramount importance, good dynamic speakers are suggested. If volume alone is desired, and where high-fidelity is not necessary (as for reproduction of speech) dynamic horn units are recommended. A happy medium may be obtained by using a dynamic speaker together with a directional baffle.

Regardless of the speaker decided upon, it should be purchased with an eye towards the following points:

1. Efficiency: An inefficient speaker requires higher powered amplifiers to produce a given volume of sound.
2. Sensitivity: Insensitive speakers cannot be operated at low levels without introducing considerable frequency distortion.
3. Frequency Discrimination: For high-fidelity work, a loudspeaker should have minimum frequency discrimination or all of the care and expense involved in selecting a high quality amplifier, microphone, etc., will have gone to waste.
4. Power Handling Ability: An important factor in outfitting a sound car is to use a

Announcing
TRIPLITT

VOLT - OHM - MILLIAMMETER

IN KIT FORM!

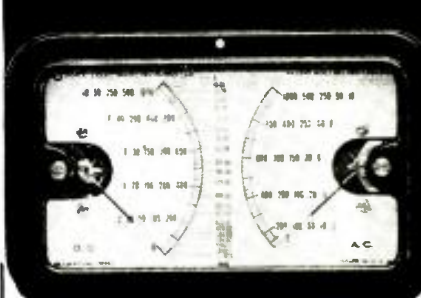

No. 1200

SERVICE men who want to build their own instruments, or who want to use instruments, that can be made to fit special space and installation requirements will be particularly interested in Triplitt No. 1200 Volt-Ohm-Milliammeter. Now, it is available in kit form, and is designed for use with built-in job equipment.

Every necessary item is included in this kit—and all assembly details have been carefully worked out. All you need is soldering iron and a pair of pliers. The complete kit includes these units.

Triplitt Twin Meter.....	\$10.33
Special Triplitt Selector Switch, net	1.67
Shunt Board for 1-10-50-250 milli-ampere readings; 1500 ohms and 11 megohms, net	2.33
Resistor board for 10-50-250-500-1000 DC Volts and 50-250-500-1000 AC volts and current limiting resistors for 1500 ohms and 1 1/2 and 3 megohms, net	4.83
.5 MFD Condenser for output measurements, net	.33
Rheostat Assembly, consisting of 65-6000-9000 ohm resistors for ohmmeter zero adjustments, net	1.67
Set of Blueprints and Instructions, net	.67
Hook up wire, net	.33
No. 32 Triplitt leads, net	.50
SEE YOUR JOBBER	
See this complete kit at your jobber's.	
Total price, complete kit, net to dealers	\$16.67

THE TRIPLITT ELECTRICAL INSTRUMENT COMPANY
117 Main Street Bluffton, Ohio, U. S. A.

Please Say That You Saw It in RADIO-CRAFT

ELECTRICAL BOOKS shipped **FREE**

10 BIG BOOKS

A-C-RADIO TELEVISION
Every Electrical Subject Covered

Here's great news for anybody interested in Electricity. BRAND NEW edition of Applied Electricity brought right down to date with every NEW electrical subject fully covered. 10 big Volumes and all shipped FREE for examination.

BIG FIELD! Big Demand Big Pay! Men who understand electricity are urgently needed right now in thousands of industries. Autos, airplanes, machine shops—practically every industry depends on electricity and men who know this subject make big money. Pleasant, fascinating work, easy to learn and do; learn quickly with these books. Send coupon for a set for FREE examination and see for yourself.

FOR BEGINNERS and EXPERTS
Over 3000 pages—hundreds of illustrations—the most complete work of its kind ever published. Dynamos, motors, power stations, radios, television, everything electrical clearly so anyone can understand them.

FREE A year's consulting membership in the American Technical Society now given free to all readers of this famous Cyclopedia of Electricity. Many say, "That's worth more than cost of books."

AMERICAN TECHNICAL SOCIETY
Drexel at 58th St., Dept. E326, Chicago

AMERICAN TECHNICAL SOCIETY,
Dept. E326, Drexel at 58th St., Chicago.

Send for 10 days' free use. BRAND NEW 10 volume set of Electrical Engineering. In return for mailing this coupon promptly, send absolutely free certificate of membership in the American Technical Society entitling me to free consulting privilege for one year. I will pay the few cents delivery charges on the books. If I wish I may return them in 10 days and owe you nothing, but if I keep them I will send \$2.00 after 10 days, then \$3.00 a month until the special sale price of only \$29.80 is paid.

Name
Address
City State
Please attach letter giving age and occupation and the name and address of at least one business man as reference.

All-Purpose AMPLIFIER



UNIVERSAL AC-DC AMPLIFIER \$18.95 KIT OR PARTS

PORTAMP—a new sensation in Portable Power Amplifiers, designed by skillful engineers of LEOTONE Laboratories. This fine portable P. A. System delivers the "punch" required for operation in auditoriums and outdoor advertising work... always clear audible reproduction.

It features a 77 tube in the first stage which feeds into a 43 power pentode. The rectifier is a 25Z5 arranged for universal operation on 90-125 volts, A.C. or D.C. A "mike" transformer is built-in. "PORTAMP" Kit including Brown Morocco Leatherette carrying case, American "EL" double-button microphone, microphone transformer, kit of ARCTURUS tubes and speaker. COMPLETE \$18.95 Wired and Tested..... \$21.95

LEOTONE RADIO CO. 61 Deu St. New York, NY

THE WORLD'S MOST COMPLETE CONDENSER LINE

FOR Service Men Amateurs and Experimenters Paper - Mica Oil Electrolytic

CORNELL DUBILIER CORPORATION
4347 BRONX BOULEVARD NEW YORK

WRITE FOR OUR CATALOG TODAY

Backed by twenty-five years of scientific research and quality production. One since 1910. Available at all leading suppliers. Use a C. D. the next time.

sufficient number of speakers to adequately handle the energy delivered to it from the power amplifier. For ideal conditions, the rated output of the amplifier is divided by the continuous power handling ability of the speaker in order to determine the number of units to use. For example if 25 watts of audio energy are to be handled by speakers rated at 5 watts, 5 speakers will be required.

5. **Ruggedness:** Sound truck systems probably get more rough handling than any other type of sound amplifying devices, it therefore is of utmost importance that the speakers be not only capable of withstanding the normal operation of the amplifier, but they must be so constructed that jars and jolts should not throw the delicate moving coil out of adjustment. Of course precautions should be taken in the installation of the speaker system to insure atmospheric protection. Stormproof housings for externally mounted dynamic speakers are an absolute necessity.

For best results the outdoor horn should be made of a thick non-resonant material, reinforced with heavy metal wherever needed and finished with many coats of some high-grade water proofing material capable of withstanding the most severe weather and abuse.

Speaker Field

If the P. A. system is to be used temporarily in a sound car, provision should be made for field excitation for the dynamic speaker from a 6 V. storage battery as well as from a 110 V. A.C. This is best accomplished by employing speakers with 6 V. fields and appropriate 110 volt exciters for operation from power lines.

The question of baffles, horns, and trumpets is of extreme importance inasmuch as the correct selection of the appropriate will considerably aid the overall performance of the entire system. Where the directional properties of the loud-speaker system is of no importance baffles should be used for the dynamic speakers. The sides of small trucks may easily serve as effective baffles for as many as twelve speakers (Fig. 2B). If sound is to be projected for a considerable distance, experimental-type horns are recommended; these may be permanently or temporarily mounted as illustrated in (Fig. 2A and C). Where short range wide-angle coverage is desired a short wide-angle trumpet should be used (Fig. 2D). Such an arrangement offers the advantages of both directional and quality reproduction.

By using special speakers on adjustable stands, they may be faced in any direction and sound projected wherever desired. It is thus possible to point the speakers upwards to a grandstand, or downwards towards people gathered around the sound car and to change the direction of sound projection depending upon the particular application.

Additional Accessories

A good storage battery is absolutely necessary if any considerable amount of sound truck work is contemplated. While the car battery can be used to operate the amplifier, this procedure is not recommended unless the charging rate of the generator can be advanced to compensate for the drain of the entire sound system. A separate storage battery and a storage battery charger is a good investment for any P.A. technician. By using a separate battery, the car battery can be reserved for emergencies.

For elaborate installations which are to be used for talkie picture work, a screen can be built into the body of the truck, as a partition, and the film projected either from the rear or the front of the screen. For this type of application, provision must be made within the amplifier for exciter lamp current, photo-cell voltage, and a suitable photo-cell to grid input coupling circuit.

A good supply of multi-wire cable and extension wires should be on hand to meet all unusual installations and ordinary conditions requiring remote pickup or sound distribution.

Truck, Trailer or Service Car

For those individuals who prefer not to mutilate their private cars, and those who expect to make extended trips with their sound equipment, a trailer is highly recommended. These are easily fastened to any tonneau and are excellently adapted for housing the entire P.A. system. There is usually sufficient room to arrange comfortable sleeping quarters within the trailer.

For general all-around purposes any automobile can be easily adapted for public address work and converted into a "sound truck."

A MAGAZINE WHICH NEEDS NO INTRODUCTION TO SHORT-WAVE FANS

SHORT WAVE CRAFT

This popular monthly magazine, SHORT WAVE CRAFT, contains everything you want to know about Short Waves. The wonders of world-wide short-wave reception are clearly described and illustrated. Latest practical information for radio fans, experimenters and "hams" will be found. Tells you how to build short-wave receivers and transmitters; non-trust sets of one and two tubes or as many as seven, eight or more. Tells best foreign stations to log and when to tune them—includes newest and best circuits of the time. SHORT WAVE CRAFT is edited by Hugo Gernsback.

NEW FEATURE RECENTLY ADDED—To the short wave fan who has logged and obtained verification of the largest number of short-wave stations from all over the world during one month, will be awarded a magnificent 24" silver trophy.

Special This Month Only!

For the month of January only, we offer readers of this magazine the opportunity to read radio's greatest short-wave magazine at a special saving. The regular subscription price is \$2.50 per year. You can now get SHORT WAVE CRAFT for the next

8 MONTHS FOR \$1.00



4-Color Cover
Over 200 illustrations
9x12 inches in size

25c The Copy
ON ALL NEWSSTANDS

Send remittance by check, money order or U. S. Postage Stamps. Register letter if it contains cash or currency.

SHORT WAVE CRAFT
99R Hudson St. New York, N. Y.

CLASSIFIED ADVERTISEMENTS

A. C. GENERATOR
10 PRACTICAL AND LOW-COST CHANGES converting Dodge 12-V., Ford T. A., Chevrolet Delco 6-V. generators into 100-500 watt capacity A.C. generators, or into 32-110 V., D.C. motor or generator. Dodge is 500-W. self-exciter. All in one book illustrated with complete simplified instructions and drawings for only \$1. Autopower, 410 S. Hoyne Ave., Chicago.

ELECTRICAL SUPPLIES
INSULATION, WIRE, VARNISHES, SUPPLIES, etc. Send 3c stamp for bulletin. Autopower, 410 Hoyne Ave., Chicago.

PATENT ATTORNEYS
PATENTS—REASONABLE TERMS. BOOK and advice free. L. F. Randolph, Dept. 562, Washington, D.C.

PATENT INVENTIONS IS MY SPECIALTY through 28 years; Sterling Buck, Registered Patent Attorney 7780, 629 F, Washington, D. C. (Free Booklet-R).

RADIO
FOR SALE: DEFOREST RADIO TUBES purchased in 1933. Used for only one month. 2—vacuum tubes—type 571 and 2—vacuum tubes, type 572. Write for particulars or send your offer to Cherry-Burrell Corp., Little Falls, New York.

NEW LONG DISTANCE CRYSTAL RECEIVER. Blueprint, 17 others, 25c coin. Particulars free. Modern Radiolabs, 151-B Liberty, San Francisco, Calif.

RADIO INSTRUCTION
RADIO ENGINEERING, BROADCASTING, aviation and police radio, Servicing, Marine and Morse Telegraphy taught thoroughly. All expenses low. Catalog free. Dodge's Institute, Pine St., Valparaiso, Indiana.

SALESMEN WANTED
RADIOS—LONG-SHORT WAVE. BATTERY or Electric. No-cost sample. 20th Century Co., R-2492, Kansas City, Mo.

Please Say That You Saw It in RADIO-CRAFT

Installation

Before the actual installation work is started, definitely decide whether it is to be of temporary or permanent nature. If it is to be for temporary use, then the equipment is placed into the most convenient operating position. The speakers are securely tied to top of the car and arranged so that they can be easily removed without damaging the auto or the speakers.

If permanent installation is contemplated, (and this should not be done until a satisfactory temporary arrangement has been worked out) it is best to enlist the aid of an experienced auto body worker so that a professional appearance is attained.

The most convenient permanent installation is provided by arranging the outfit in a rack-and-panel form so that all controls are alongside the driver's seat and within easy reach. For rough country work, the phono. turntable should be carefully suspended on springs so that the needle will not "jump" the record groove while the auto hits the road "bumps."

The speakers can be mounted in any one of the ways illustrated in Fig. 2. (sketches of autos and speakers) depending upon the type and number employed.

Getting the Business

Assuming that you have outfitted your truck, the next series of questions you will ask are:

- Who are my best prospects?
- How can I sell my service?
- Mow much shall I charge?

The answers to these questions are found in the following quotations taken from statements made by successful men in the P.A. field.

Best Prospects

"We find that in the summer, we solicit picnics, lawn fetes, street dances, conventions, boat races, rallies, and fairs. In the fall sports such as football, hockey, etc., as well as clubs, industrial plants, hotels, auditoriums, and churches are good prospects, too!"

"For outdoor events, bridge openings, dedications, etc., our mobile equipment serves well. Also, street advertising is done for people who are interested in reaching many people, such as merchants, wholesalers, and manufacturers."

"Our sound truck nets most of its business by virtue of its reputation. Department stores, automobile distributors, theatres, and others, approach us for its rental."

Selling the Service

"No cut and dried method has been found for going after rental business. It is entirely up to the individual organization and its facilities for contacting prospects."

"Continued personal contacts and our reputation bring in many new jobs."

P.A. Rental Rates

"A charge of not less than \$50.00 per day is made and this ranges up to \$200.00 per day for our largest equipment."

"Charges vary with the character of each job—depending on the type of equipment required, the time consumed in making the installation and taking it down when finished, and the amount of engineering necessary."

The authors will be pleased to answer all questions relative to the points discussed in this article—inquiries should be addressed to RADIO-CRAFT.

SHORT CUTS IN RADIO

(Continued from page 533)

6TH HONORABLE MENTION

IF YOU Service Men are troubled with blown fuses when a customer brings in a shorted set for repairs, you might hook up a device like this (Fig. 5) and save the trouble. It is nothing more nor less than a 25 W. lamp in series with a fuse and a 110 V. outlet, and a single-pole double-throw switch to short the lamp. When the device to be tested is plugged in, the brilliancy of the lamp indicates the condition of said device. If it glows brilliantly there is a complete short in the radio set. If it glows dully, the set is safe to put on the line when the switch is placed so as to cut in the fuse. This can be tried out with motors, transformers or any other repair part.

W. E. GRANCHIE

A SIMPLE ALL-WAVE OSCILLATOR

(Continued from page 544)

to drop the voltage to the correct value.

The three sets of coils, values of which are given here, are connected into the circuit by a rotary switch which breaks both the grid and plate circuits.

The tuning is accomplished by a 406 mmf. condenser which is supplemented by a trimmer for close adjustment.

The top scale of the dial reads from 132 to 380 kc. and is marked for all the useful intermediate frequencies such as 400, 450, 456, 465, kc., etc., as harmonics of the fundamental frequencies. The same top scale is used also for the short waves, from 1320 to 3800 kc., by simply adding a zero to the scale reading. The short-wave range is thus 10 times higher than the low frequency range. The broadcast band, from 530 to 1520 kc. is read directly on the bottom scale.

The coupling of the oscillator to a set which is to be adjusted is accomplished by a wire which is run parallel to the plate lead, thus producing a capacitive coupling which is both simple and effective. It provides a suitable degree of coupling without direct contact, thus eliminating any possibility of short circuit in the set through the power lines.

List of Parts

- One set of coils (described in Fig. 2) L1T1, L2T2, L3T3;
- One tuning condenser, 406 mmf. with trimmer;
- One 350 ohm power cord;
- One three-point, two-section switch;
- One 50,000 ohm 1/2-watt resistor;
- One 500 mmf. mica condenser;
- One extra trimmer, 75 to 100 mmf.;
- One 5-prong socket;
- Three tubular spacers 1 1/2-in. for condensers;
- Two double lug standoff insulators for mounting coils;
- One Eby "Gnd." binding post;
- One Eby "Output" binding post;
- One engraved disc for switch;
- One bakelite panel, 7 1/4x8x5/32-ins.;
- One carrying case, steel or aluminum, 2 1/2 ins. deep, with handle;
- One metal bracket for mounting tube, condenser and fuse;
- One fuse block (automobile type);
- Screws, bolts, lugs, etc.

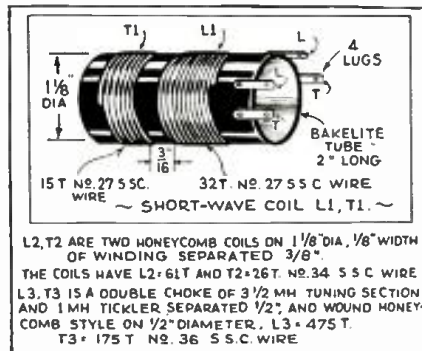

Above, Fig. 2. Oscillator coil detail.

Below, Fig. 3. View showing parts arrangement.

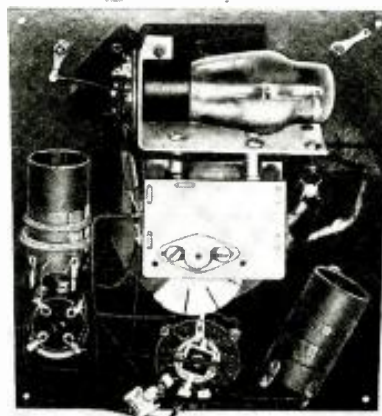

Please Say That You Saw It in RADIO-CRAFT

POWERFUL NEW AMPLIFIERS

by

WEBSTER CHICAGO

THE SERIES 358 15 WATT CLASS "A" AMPLIFIER



A new, flexible all-purpose Webster amplifier around which a variety of sound systems may be assembled. For auditoriums, churches, schools, clubs, factory and office call systems, and for all indoor installations requiring quality reproduction at an attractive price, the Webster 358 Class "A" amplifier is the ideal unit. Features a three stage Class "A" circuit distinguished for fidelity and for skillful minimizing of hum level. Incorporates the original Webster "stabilized bias" feature assuring maximum undistorted 15 watts output without the use of a separate bias tube. Provides dual control system for "mixing" both phonograph and microphone, with built-in microphone current supply. Equipped with tone control. Has universal output. Completely contained in a well-ventilated steel case, with tubes and terminal strip easily accessible. Effectively fused for protection. The Webster Class "A" 358 Amplifier is the logical choice for quality installations where fidelity and hum-free operation are of prime importance. Write for detailed descriptive bulletin.

CLASS "B" 26 WATTS

Where higher volume levels and wide range coverage are required, Webster offers the 26 watt Class "B" version of the 358 series. Essentially the same in appearance, input and output characteristics as the Class "A" unit. Particularly suited for outdoor use with multiple speaker arrangements. There is a wide market for this moderately priced powerful unit. Send for complete details.

WRITE FOR CATALOG!

Sound specialists, Engineers, Radio Servicemen, Dealers and others who are interested in Sound installations—write for free bulletin describing the Series 358 units, as well as for the valuable complete Webster listing of Sound Equipment covering all types of installation requirements. Submit your sound problems to Webster engineers for complete recommendations and advice at no cost to you. Write now!

WEBSTER CHICAGO

3825 W. LAKE ST., CHICAGO, ILL. Dept. R

- Please send me Free bulletin covering the Series 358 Webster Amplifiers.
- Please send me the complete Webster Sound Catalog. I am interested in installations as described in the letter attached.

Name

Address

City..... State.....

LET ME HELP YOU ... MAKE MONEY SELLING RADIOS

Since 1921 I have shown 7800 men how to meet any and all Radio competition and make good profits for themselves. I can do the same for you.

Make all the profit . . . you don't need to split profits with any dealer or jobber. You don't need to compete with stores who are forever cutting prices. Sell your own fine. Control your own retail prices. . . high, to cover trade-ins and low, for all cash. But above all, you'll find MATHESON BELL radios to be of a quality that any service man can be proud to sell.

My organization is the only one of its kind. I do not conduct a mail order business . . . I sell through radio service men only . . . I do not sell through regular jobbers and dealers. I have one price . . . no extra discounts and . . . my lowest price goes to radio service men. I would not knowingly sell a radio direct to a customer for his own use. I believe that the right kind of radio service must be . . . back of every radio.

The service man who sells and guarantees a radio is entitled to know that it is of a quality which will not tear down his reputation when he has worked so hard to build up. Your customers believe in you . . . they are willing to take your word for a radio. Then treat that confidence as it should be. A well-known name, created by a lot of advertising . . . does not . . . necessarily mean a radio . . . that YOU . . . can heartily recommend.

I believe that I know the service man's problem . . . I ought to. I have been designing and manufacturing radios . . . exclusively for service men for thirteen years . . . from way back in the No. 200 Detector tube days. Let me show you how to make good money selling radios . . . exactly fitted for your purpose.

I make all sizes from a five tube broadcast receiver with guaranteed 16 K.C. selectivity at \$16.95 to a master twelve tube, two band, in a cabinet with 1 1/2 inch solid walnut tone chamber, Six, seven and ten tube A.C. with European band. In battery radio; air cell; two volt; six volt no. "H" batteries and 32 volt. and . . . an auto radio which I will guarantee to equal, if not outperform, any auto radio at a cost to you of only \$23.95.

Drop me a line giving your name and address. You'll make good money by being on my mailing list. Illustrated literature is without cost . . . write for it today.

J. MATHESON BELL, INCORPORATED
308-Dept. A, West Randolph Street Chicago

Truly a Pioneer!

This modern all-wave receiver features every conceivable improvement known in radio today—it is a receiver that you will be proud to own.

The "MJ" receiver for the truly critical listener.



Write for Complete Details on this Modern All-Wave Receiver

Pioneer Sound Laboratory
135 Liberty St., New York, N.Y.

+ FIRST AID +

In servicing condenser breakdowns, use these ultra compact general utility condensers . . . smallest stock and investment for biggest utility and profit.

The smallest sized electrolytics for Green electrolytes and voltages . . . each unit housed in two wax-impregnated cardboard cases wax-filled to prevent evaporation or moisture absorption. Order from your jobber, today!

FREE DATA: Write for new 1935 catalog, just out. Also sample copy of our monthly Research Worker.

AEROVOX CORPORATION
77 Washington St. : : Brooklyn, N. Y.

HOW RESISTORS ARE MADE

(Continued from page 545)

molded under relatively low pressures. Practically it really represents a number of semi-round carbon pebbles which touch each other with a point contact. Therefore, the paths and areas through which current may travel are reduced greatly by the large bulk of insulating particles, and this to a tremendous degree further by the point contact condition.

The current density must be considered microscopically, and consequently has heretofore not been stressed to the extent its importance warrants. A study of micro-photographs will bear this out. It shows that the structure of such units is not uniform and contains many voids, irregularities and inclusions. It is seen that the mass is not solid but porous and contact is "point" contact only. Therefore the current-carrying cross section is microscopic, and the current density must of necessity be very high at such points or areas. This has been proven by studying under high-powered microscopes the action of the units under both normal and excessive loads. Glowing points of light were observed proving the intense microscopic current density. Naturally, such points would tend to alter their characteristics both physically and mechanically.

Further study was made of resistance values under mechanical loads, and the changes noted under such loads were to be expected in accordance with the above facts.

With these considerations in mind a resistance was developed which technically and practically would overcome these objections. First, instead of a background material of very high insulating value, a background material which is in itself a resistance material has been substituted. To vary this material and to get the desired resistance values another resistance material of lower value is introduced. The entire mass, after it has been reduced to absolute uniformity is then subject to tremendous pressure and under such pressure extruded into rods.

Consider then the result. Instead of a very small percentage of the cross section being of a current-carrying material, the entire cross section is current carrying. Further, the cross-sectional area is not composed of a great number of voids and a relatively small number of points of contact, but is microscopically one solid uniform compact current-carrying mass. This is the result of the tremendous pressure, the method of extruding, and the composition of the material itself. In fact, these new units are so uniform that they resemble the micro-photographs of a section of a gun forging. This current-carrying area is large and non-microscopic, and this in itself explains many other results as shown in the succeeding paragraphs.

A study of these units under mechanical loads, shows that the resistance value remains constant. This is a most significant fact. Microscopic study under normal and excessive wattage shows that "light" points, or points of excessive microscopic current density do not exist.

The Results of Tests

The method of attaching ends to these units has also been subject to a similar technical study and development. It was desired to secure a uniform sound area of contact, and then to place on this area of contact a metal surface which in itself has sufficient strength and rigidity to be positive in its action. The coating of the ends of the resistor with fine particles of metal produced the first consideration. The second requirement was met by placing on the end of the resistor and over this metal-coated surface a solid piece of metal in the form of an end cap to which end cap was integrally attached the pig tail. In this fashion a much sounder terminal construction was arrived at than in most instances.

The physical appearance of the unit bears out these facts. One finds a solid extruded mass, homogenous, and rock-hard which is a conductor throughout its entire body, has a smooth velvety finish, which in itself is ideal for heat radiation. The diameter and length is uniform.

Current Rating

The watting ratings are exceptionally conservative for the sizes have been kept standard (to the usual type resistor (dimensions) rather than reduce the bulk in keeping with the greater

Air Conditioning

is America's Next Great Industry

THE idea of electricians, radio service men and other mechanically inclined men servicing Air Conditioning and Refrigeration Units is self-evident and the thought has occurred to some untold thousands ever since air conditioning equipment has been installed in public auditoriums, theatres, studios, department stores, office buildings and manufacturing plants. The tremendously broad possibilities in this new industry are bound to give employment and success to men far-sighted enough to see its advancement and development.

Well-known Engineer Edits Manual

The OFFICIAL AIR CONDITIONING SERVICE MANUAL is edited by L. K. Wright, an expert and a leading authority on air conditioning and refrigeration. In this Air Conditioning Service Manual nearly every page is illustrated; every modern installation and individual part carefully explained; diagrams furnished of all known equipment; special care given to the servicing and installation end. The tools needed are illustrated and explained; there are plenty of charts and page after page of service data.

CONTENTS IN BRIEF

History of Air Conditioning; Fundamental Laws; Methods of Refrigeration; Ejector System of Refrigeration; Compression System of Refrigeration; Refrigerants; Lubricating Oils; Liquid Throttle Devices; Servicing Expansion and Float Valves; Servicing Refrigerating Systems; Control Devices; Thermodynamics of Air Conditioning; Weather in the United States; The Field of Air Conditioning; Insulating Materials; Heat Transmission Through Walls; Complete Air Conditioning Systems; Estimating Requirements for the Home, Small Store, Restaurant; Layout of Duct Systems; Starting Up a System; Operating and Servicing Air Conditioning Systems; Air Filtration; Ventilating and Noise Eliminating Devices; Portable Electric Humidifiers and Room Coolers; Automatic Humidifiers; Air Conditioning Units for Radiator Systems and Warm Air Systems; Central Conditioning Units, etc.



9x12 Inches
352 Pages
600 Illustrations
Flexible, Loose-Leaf
Leatherette Cover
\$5.00 A COPY

(Send remittance by check, money order or unused U.S. Stamps. Register letter if it contains stamps or currency.)

GERNSBACK PUBLICATIONS, INC.
599 Hudson Street New York, N. Y.

Know Thyself!

Well Illustrated

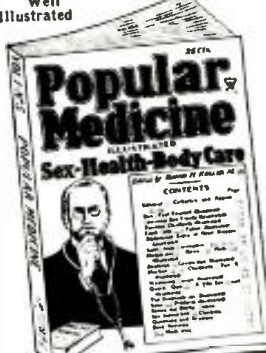

This new monthly magazine is also your own doctor. WHAT AILS YOU? POPULAR MEDICINE tells and a U.S.P.C. Son thoroughly. Written for you by doctors. Non-technical yet authoritative for all laymen. Many anatomical illustrations.

Special Offer!
8 Months \$1 for

Send 25c for sample copy POPULAR MEDICINE
599 Hudson St., New York, N. Y.

On All Newsstands

PIRATE STORIES

For March
A COMPLETE BOOK-LENGTH NOVEL
"Pirate Vengeance"
By CAPTAIN DINGLE
A Flaming Tale of Buccaneer Days
Also Short Stories of Modern Pirates
by Capt. J. Winchcombe-Taylor
George Allan Moffatt and others
A GERNSBACK PUBLICATION
15c The Copy—On All Newsstands

The Breakers

ON THE OCEAN FRONT
ATLANTIC CITY, N. J.

Situated directly on the Boardwalk and convenient to all Piers and Amusements

PER DAY per person	\$6.00	With Meals Private Bath
EUROPEAN PLAN	\$3.00	Private Bath

Hot and cold sea water in all baths
Excellent Food—French Cuisine
Garage

EMANUEL E. KATZ, Man. Director



There's plenty of SERVICING MATERIAL in the 1934 Manual!

Radio Service Men and others engaged in various branches of radio know the importance of the GERNSBACK Manuals, and how much they depend on them for reliable information. Whether for public address work, receiver diagrams or tube information, the material needed is certain to be found in one of the volumes of the OFFICIAL RADIO SERVICE MANUAL.

Contents of the 1934 Manual in Brief

Diagrams and service notes, more complete than ever before in any manual. Voltage readings for practically all sets, as an aid in checking tubes and wiring. All values of I.F. transformers used in superheterodynes, with the manufacturers' own suggestions as to correct balancing. A complete compilation of radio tube data, covering both old and new types. A complete list of American broadcast stations with their frequencies in kilocycles; extremely useful in calibrating test oscillators and receivers. Free question and answer service. No theory; only service information in quickly accessible form. A handy, easily-consulted master index making it easy to find almost any thing pertaining to service problems. Instantly. This index includes all the diagrams published in all the previous GERNSBACK manuals, as well as the 1934 diagrams. A big convenience and time saver.

400 PAGES
Over 2,000 Illustrations
9 x 12 Inches

Flexible Looseleaf Leatherette Cover

Send remittance of \$3.50 by check, money order or unused U. S. Postage Stamps. Register letter if it contains cash or stamps. **MANUAL SENT POSTAGE PREPAID.**

GERNSBACK PUBLICATIONS, Inc.
99 Hudson Street, New York, N. Y.

Enclosed find my remittance of \$3.50 for which send me, **Postage Prepaid**, One Copy of the 1934 OFFICIAL RADIO SERVICE MANUAL. [Send remittance by check or money order; or register letter if it contains cash, currency or unused U. S. Postage Stamps.]

Name.....
Address.....
CITY..... State.....
RC-3-35

wattage dissipating properties of the unique conducting mass.

These units have been in actual existence and on test for some years and have been in their final form for more than a year.

The first consideration in testing was to apply load. All loading was applied initially at double wattage, with no effect on the value of the unit. Increased load was applied in the presence of elevated temperatures, still the units were able to show no change in value. Tests were made on an intermittent basis and the loads were varied from less than normal to more than double load. Tests were carried out by many different groups, and were highly satisfactory.

One of the most recent tests shows that not a single unit dropped in value under various loads up to double wattage and voltage up to 880 volts and greater. Variation of load of any one unit was less than 2 per cent, but the majority of the units were fractions of 1 per cent. In fact, loads in excess of 1 watt were placed on the 1/4-watt units.

These units were tested also under usual humidity conditions and found to be without change. They were then placed in water for varying periods of time, and again satisfactory results. Further, these units have been subjected to many unusual tests: such as putting them directly into water; into boiling water; and into live steam with satisfactory results.

A "3-IN-2" SHORT-WAVE SET

(Continued from page 544)

all difficult, as the chassis can be obtained completely drilled and ready for assembly. The positions of the parts are evident from the two photos and the circuit diagram here. A list of parts follows for those who are interested in constructing this unique little receiver.

List of Parts

- One ICA metal panel and sub-panel with excutcheon plates;
- One 140 mmf. tuning condenser, C1;
- One 50 mmf. midset variable condenser;
- One set ICA 6 prong plug-in coils, 16 to 200 meters;
- One 4 prong socket marked 32;
- One 6 prong socket marked 19;
- One regeneration control 0-2000 ohms;
- Two .100 mf. condensers;
- One 100 mmf. grid condenser;
- Two .02 mf. coupling condensers;
- Two 1 mf. bypass condensers;
- One ICA antenna condenser;
- One 1 meg. grid leak;
- One 5000 ohm resistor;
- One 50,000 ohm resistor;
- Two .5-meg. resistors;
- Two .1-meg. resistors;
- Two ICA dial drive assemblies;
- One ICA mounting bracket for 5 plate condenser;
- One pair of phone tip jacks;
- One 10 ohm rheostat;
- One ICA coil shield with 6 prong socket;
- One ICA battery connecting strip;
- One RCA Radiotron or Sylvania type 32 tube;
- One RCA Radiotron or Sylvania type 19 tube;
- Three small 45 V. "B" batteries;
- Two No. 6 dry cells;
- One 4 1/2 V. "C" battery;
- One pair ICA phones;
- As needed, screws, washers, wire, etc.

INTERNATIONAL RADIO REVIEW

(Continued from page 529)

Another set along the same lines, but permanently installed in the chair, was announced in the latest issue of Radio and ELECTRICAL MERCHANT, a trade magazine published in Sydney, Australia.

This set, which is a commercial item, is shown in Fig. C. The tuning controls are recessed into the arm of the chair, which is a leather-covered one of the "club" variety. The entire set, with all the power units and the speaker is concealed in this chair.

Now! SAVE UP TO 50% BY BUYING YOUR RADIO DIRECT FROM MIDWEST LABORATORIES



ONLY RADIO COVERING 9 TO 2,400 METERS
GUARANTEED FOREIGN RECEPTION
Amazing New MIDWEST HIGH FIDELITY 16-TUBE ALL-WAVE Radio!
(ALL 5 WAVE BANDS) ONLY

EXCLUSIVE features, acting like "Invisible Hands," give magical world-wide High Fidelity reception. Before you buy any radio, write for **FREE** 36-page four-color catalog. Learn how thousands saved 1/3 to 1/2 by buying direct from laboratories. This Super De Luxe, 16-tube All-Wave radio gives you: High Fidelity reception, 5 wave bands, 50 advanced features, many of them exclusive...such as Multi-Function dial. Only Midwest offers you 9 to 2,400 meters. Brings in foreign stations 12,000 miles away.

\$57.50 with **NEW DELUXE AUDITORIUM-TYPE SPEAKER**
30 DAYS FREE TRIAL

Hear realistic American and **SHORT WAVE** programs...Canadian, police, amateur, airplane, ships. One-Year Guarantee, Foreign Reception Guarantee, Money-Back Guarantee. As little as \$5.00 down. 30 days Free Trial. **Long Range Radios \$27.50 as Low as**

MAIL COUPON TODAY... FOR FREE MINIATURE DIAL... FREE 30-DAY TRIAL OFFER... FREE CATALOG

Midwest Radio Corporation
Dept. 36-A CINCINNATI, Ohio
Without obligation send me your **FREE** catalog, **FREE** Miniature Dial, and 30-day **FREE** trial offer. This is **NOT** an order.
Name.....
Address.....
Town..... State.....
 Check here if interested in a battery radio.

JUST OFF THE PRESS!

NEW 1935 BIG BARGAIN RADIO AMPLIFIER CATALOG

SEND For Your Free Copy Today

We Have **MOVED** to considerably **LARGER QUARTERS** to give you **FASTER SERVICE!**

We now occupy over **FOUR times MORE SPACE.**

WE ARE HEADQUARTERS FOR PUBLIC ADDRESS SYSTEMS
Buy Direct from the Manufacturer and Pay Only One Profit
COAST TO COAST RADIO CORP.
559-565 K 6th Ave., New York, N. Y.



NOW READY!

NO other radio book is comparable to the new 1935 OFFICIAL RADIO SERVICE MANUAL. In contents, in style of printing, in grade of paper, in illustrations, there has never been published such a comprehensive volume.

The 1935 Manual contains over a thousand pages—yet it is only 1¼ inches thick because it is printed on a special Bible stock which is an exceptionally good stock, yet one of the thinnest and most durable papers. This 1935 Manual is the most authentic and elaborate service guide ever used in the radio industry. Service Men and dealers who use this 1935 Manual are astonished by finding in it such a wealth of profitable service information which has never been published before.

Contents of the 1935 Manual

Over 1,000 pages full of diagrams and essential information of manufactured receivers—only data of real use in servicing is included. This new Manual is really portable since it will be extremely thin and light as well. ● Volume V continues where the preceding manual left off. ● Many circuits of old sets are included. ● Service Men know every set has certain weak points which are really the cause of trouble. Wherever the information could be obtained, these weaknesses with their cures are printed right with the circuits. This is an entirely new and valuable addition to the Manual. ● All the latest receivers are included—all-wave sets, short-wave sets, auto-radio sets, midret and cigar-box sets, etc., as well as P.A. amplifiers and equipment, and commercial servicing instruments. ● The cumulative index is even more complete than before; including cross-reference to sets sold under different names and type numbers. ● Volume V includes resistance data; socket layouts; I.F. data; and voltage data. ● Tube data on latest tubes. ● Free question and answer service—as included in our last three manuals.

OVER 1,000 PAGES

Over 3,000 Illustrations. Flexible, loose-leaf leatherette covers. Size 9x12"—yet only 1¼" thick

GERNSBACK PUBLICATIONS, Inc.
99 Hudson Street New York, N.Y.

MAIL COUPON TODAY!

SET SERVICING
Service information found in the 1935 Manual covers all types of radio receivers. The material is extremely valuable to Dealers and Service Men. On many diagrams appear voltage readings of tubes, socket connections, transformer data, alignment details, and other service notes.

PUBLIC ADDRESS
The pages on P. A. Installation will be helpful to Service Men and P. A. specialists. Such prominent features as class A and B amplifiers—single and dual channel systems—attenuators, and mixers—superpower stages—pre-amplifiers and other commercial devices for P. A. work are included.

ALL-WAVE RECEIVERS
Information relative to short-wave receivers have found their way into the 1935 Manual. For these standard manufactured sets, wherever possible, complete aligning details for all wave bands are included in addition to the service material listed for other sets.

AUTO-RADIO RECEIVERS
All available service information on new auto-radio sets has been included. From this data alone Service Men could derive sufficient knowledge to venture in a specialty field—that of servicing only auto-radios.

GERNSBACK PUBLICATIONS Inc., 99 Hudson St., New York, N.Y.

Enclosed find my remittance of \$7.00 for which send me, POSTAGE PREPAID, One Copy of the 1935 OFFICIAL RADIO SERVICE MANUAL. [Send remittance by check or money order; or register letter if it contains cash, currency or unused U.S. Postage stamps.]

NAME

ADDRESS

CITY STATE RC-3-35

ADDING A "TWEETER" FOR HIGH-FIDELITY

(Continued from page 543)

to and slightly beyond 8,000 cycles. This device is made for use in both radio receivers and public address equipment. It requires no additional transformer or filter network since it can be connected directly across the primary of the dynamic reproducer transformer. It may even be mounted and suspended within the cone of the larger type dynamic speakers. Several units pointing in different directions may be utilized satisfactorily in the same assembly to give a uniformly distributed "spread" at the higher frequencies. In the case of a radio set the "tweeter" is connected directly across the output tube plate. "Tweeters" can be produced at a cost sufficiently low that there should be a considerable income possibility for Service Men and dealers.

National Union Radio Corporation recently announced the most complete chart yet developed. Carries a wealth of information about characteristics, interchangeability and base pin connections of 231 types of tubes. It can be used as a wall chart or in a binder. Copies can be had from RADIO-CRAFT. Ask for No. 672.

NATIONAL UNION "INTERCHANGEABILITY AND DATA" FREE TUBE CHARTS

SIMPLE I-TUBE ALL-WAVE ALL-ELECTRIC SET

(Continued from page 536)

- One variable condenser, 140 mmf.;
- One line cord, 350 ohms;
- Two 200 mmf. condensers;
- One 5 meg. resistor;
- Two .01 mf. condensers;
- One 40,000 ohm resistor;
- One .1-mf. condenser;
- Three knobs;
- One 100 mmf. antenna coupling condenser;
- One speaker jack;
- One extruded washer;
- One grid cap;
- One knurled nut.

Fig. B
Underside view of the set.

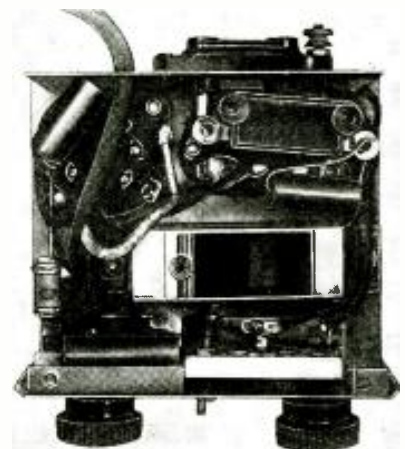

Stirring Stories of Future Science!

Here, each month, you can revel in the wonders of science and imagination through masterful tales by the world's leading authors of science-fiction. Besides many thrilling stories in each issue, you will find several interesting departments, including "Science Questions and Answers" and "The Science Fiction League"—the voice of a world-wide organization. **SPECIAL OFFER (in U.S.A. only)—One year for \$2.00. Send check or money order.**
WONDER STORIES
99R Hudson St. New York, N. Y.
A GERNSBACK PUBLICATION

HIGH SEAS

ADVENTURES MAGAZINE
For April
A COMPLETE NOVEL
"Outlaw of the Sea"
By DR. GEORGE S. KING
A Thrilling Story of the African Slave Trade
Also Short Stories by Bill Adams, P. H. MacArthur, Warren E. Carleton, etc.
A GERNSBACK PUBLICATION
15c The Copy—On All Newsstands

Please Say That You Saw It in RADIO-CRAFT

It's NOW

EVERYDAY SCIENCE AND MECHANICS is the finest scientific—technical—mechanical—constructional magazine in the field. Up-to-the-minute with news flashes of scientific events. Dosing of constructional articles and many popular experiments. Ideas from which you can make things to sell.

10¢



A MOST OF INTERESTING SUBJECTS COVERED:
 —Woodworking —Photography —
 —Magic—Patents and Inventions—
 —Book Reviews — Metal-working—
 —Chemistry—Engineering — Mi-
 —croscopy—Electrical Experiments—
 —Household Helps—Astronomy
 —Prize Contests—and other
 subjects.

Get your copy today!
 On all newsstands
10c the copy

Over 150 Illustrations

Most Amazing TYPEWRITER BARGAIN

10 DAY FREE TRIAL OFFER EVER OFFERED



NEW REMINGTON PORTABLE only 10¢ A DAY

FIRST TIME! Remington's new purchase plan now lets you buy a genuine latest model Remington Portable No. 5 direct from the factory for only 10¢ a day. Not used or rebuilt. Not incomplete. A beautiful brand new regulation Remington Portable. Standard 4-row keyboard, standard width carriage, margin release on keyboard, back spacer, automatic ribbon reverse; every essential feature found in standard typewriters.

With your machine we send you free a 19-page course in typewriting. Teaches touch system quickly, easily. Soon you dash off letters quicker than with pen and ink. You also get a handsome, sturdy carrying case free.

FREE Typewriting Course **BIG PRICE REDUCTION**



The amazing low price and easy terms now make it possible for you to buy this genuine complete Remington Portable for only 10¢ a day. But we cannot guarantee present prices long. Higher wage scales, rising cost of materials, everything points to higher prices. So we say, "Act now... while our liberal offer still holds good!"

FREE Carrying Case **You Don't Risk One Cent**



Try this typewriter in your home or office on our 10-day FREE TRIAL OFFER. Then, if you do not agree that it is the finest portable at any price, return it at our expense. You don't even risk shipping charges. Don't wait. Mail coupon now. It's the best chance you've ever had to own so complete a machine for so little money. So act NOW!

CLIP COUPON NOW

Remington Rand Inc., Dept. 189-3
 Buffalo, N. Y.

Please tell me how I can buy a new Remington Portable typewriter for only 10¢ a day. Also enclose your new catalog.

Name _____
 Address _____
 City _____ State _____

POCKET TROUBLE SHOOTER "GADGET"

Gherardi and Freed have worked out a very tricky little "gadget" that will appeal to every radio Service Man and experimenter—for, even the experienced technician will find the device useful in refreshing his memory concerning the possible causes of a fault in receiver operation.

A series of six cards, under a direction-cover measuring 5x6 1/4 ins., list, according to symptoms, 275 possible troubles in radio receivers. You merely swivel around one of these symptom cards until it is in position, and then read off the possible causes of the trouble.

The six general types of symptoms shown are: Hum; Weak; Noisy; Inoperative (no signals); Intermittent Reception and Fading; Oscillation and Distortion.

The sources of trouble are classified according to whether they are in the following locations: Power Unit; Receiver Circuits Proper; Tubes; Reproducer; Antenna, Ground; "A" Battery (if used); "B" Battery (if used); and General.

The price of this time-saving gadget is only 25c. Ask for Item No. 673.

THE LATEST RADIO EQUIPMENT

(Continued from page 539)

The unit is ruggedly constructed and has a flat frequency response range of 30 to 14,000 cycles. It is characteristically directional; this enables the reduction of acoustic feedback. The unit is not subject to variations in humidity and temperature. A universal ball joint is part of the design; a 10 ft. length of cable is furnished with the set.

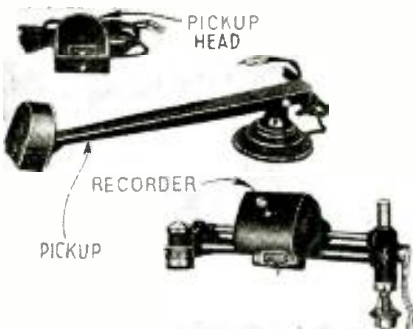

"Recording Studio" units (670).

Below, new velocity mike (671).

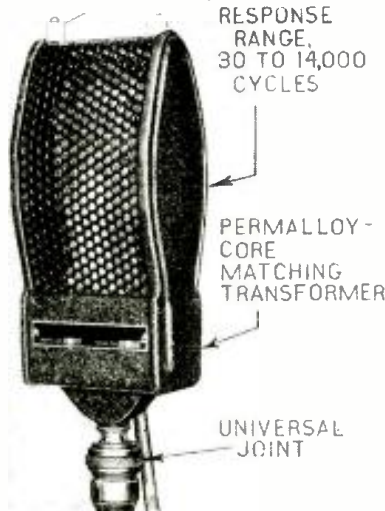

New "RCP" ANALYZERS LEAD in VALUE!

MODEL 5413
 Complete \$24.95
 KIT \$21.50



ACCURACY, completeness, fine appearance—plus convenience and provision for future needs—all at the lowest cost! What more could any analyzer provide to make your radio testing and servicing more satisfactory to your customers and more profitable to you?

FEATURES YOU WANT

The new model 5413 Analyzer has a D'Arsonval meter guaranteed accurate within 2%. Measures resistances of less than 1/2 ohm. Three-range (0-200-200,000-2,000,000) ohmmeter. Milliammeter from 0-50. Four-range (0-5-50-250-750) voltmeter, at 2,000 ohms per volt. Instantaneous automatic selector switches which make reference charts and jumping connectors unnecessary. Handsome leatherette carrying case—14 1/4" x 8 1/2" x 4 1/4". Weight 6 lbs. Complete, ready to use, with 10-wire analyzer, test prods and Sure-Grip-Pull-Out adapters, \$24.95. Kit, \$21.50.

Write Dept. RC-3 for 1935 Catalog of complete testing equipment.

RADIO CITY PRODUCTS CO.
 Dept. RC-3, 28-30 W. Broadway, New York

RADIO REPAIR MEN—AMATEURS

Sears, Roebuck and Co., The World's Largest Mail Order Company (in the Radio and Parts business for almost 20 years) announce for restricted distribution a new Radio Parts and Amateur Equipment Catalog.

24-HOUR SERVICE

Everything carried in stock—the broadest guarantee ever written—Complete satisfaction or your money refunded.

Write today for catalog No. 84R61. We will put your name on our mailing list and send you this big, new catalog as soon as it is off the press.

SEARS, ROEBUCK and CO.
 CHICAGO, ILL.

Please Say That You Saw It in RADIO-CRAFT

Modern Testing Instruments that give Accurate Measurements, Longer Service and are Lower-Priced



DEPENDABLE MULTITESTER MODEL 403-A

Service men and dealers highly praised the Model 403 Multitester—and it deserved praise. But the new improved Model 403-A "DEPENDABLE" MULTITESTER insures even greater satisfaction at less cost. Embodying every feature of the former model, No. 403-A is more compact, having been designed as a companion instrument to the new Model 501 ANALYZER UNIT described below. 2,000 ohms per volt. Accuracy within 2 per cent in D'ARSONVAL type moving coil meter. 3-range 0-2,000,000 ohmmeter; 4-range 0.5-50-250-750 voltmeter; 0-500 microammeter. **\$13.95 NET**

COMPLETE, ready to operate

KIT \$10.65

A new efficient analyzer unit combining many prominent features:—2000 ohm per volt sensitivity—Self contained 3 range ohmmeter—NO external batteries required—Eliminates referring to charts and fussing with connecting plugs—Protection against obsolescence—Entire metering system is independent of circuit switching—Free Reference Point testing—Instantly makes all Point to Point measurements between ANY TWO POINTS.

DEPENDABLE ANALYZER MODEL 5414

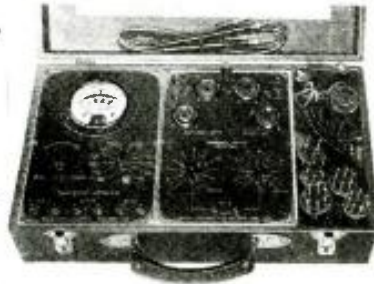

Model No. 5414 Analyzer—Ohmmeter: 0-2000; 0-200,000; and 0-2,000,000—Voltmeter: 0.5; 0.50; 0.250; and 0.250—Microammeter: 0-500—Milliammeter: 0-50—2000 ohms per volt; 3 1/4" meter; 2% accuracy. **\$24.95 NET**

KIT \$21.50

Model No. 5414—Same as above with additional Milliampere meters: Range 0-50; 0-250. Bakelite case; meter 3 1/4" x 2 1/2" accuracy. All joints and multipliers individually calibrated to within 2%. Model 5414, COMPLETE, ready to operate. **\$28.95**

KIT \$24.50



DEPENDABLE ANALYZER UNIT MODEL 501

Just connect the new "DEPENDABLE" Model 501 ANALYZER UNIT to the meter of your shunt analyzer or better still to the new "DEPENDABLE" 403-A MULTITESTER and you have a modern efficient analyzer without extensive investment. Model 501 Analyzer Unit combines all the following features: (1) Equipped with accurate chassis-ground wire with insulated leads. (2) Free Reference Point testing between any two elements, including chassis or ground. (3) Instantaneous selector switches—no reference charts—no fussing with jacks and prods. (4) Current measurements through automatic series jacks. (5) Will not be damaged by (6) R.M.A. standard model-trak at set and circuit terminals.

COMPLETE, ready to operate

KIT \$9.25

\$10.95 NET

We Issue No Catalog. All orders are F.O.B. New York. Payment a deposit of 25% is required with every order. Balance may be paid on delivery. INDUCTION 2% DEFERRED. AMOUNT IS SENT.

GRENPARK COMPANY

101 Hudson St. Dept. RC New York, N. Y.

OPERATING NOTES

(Continued from page 540)

filament and certainly burn it out. The remedy in a case like this is, of course, to install a complete set of new, first-class tubes, as new tubes of standard make are very uniform (even here, as the new tubes get older the time required for warming up increases with some individual tubes, while with others it remains constant or changes very little).

JAMES G. PIERCE

ZENITH MODEL 705

OSCILLATION in this model is frequently caused by the electrolytic condenser making poor contact with the metal. This filter condenser is located in about the center of the chassis. To cure this trouble turn condenser about 1/4-in. to make better contact.

A.K. MODELS 38 AND 42

"LOW volume" was the complaint in both cases. All voltages tested O.K. until the detector was reached. The plate voltage on this tube, a 27, read about 6 V. which should have been 45 to 50 V. To find the trouble, one must check the resistor in the plate circuit which is located in the power pack under the contact board. The trouble is shortly corrected by replacing the resistor with a new one, the old having increased in value.

CROSLLEY MODEL 148

DISTORTION was experienced in one of these sets. The trouble was found by checking the current flow in the plate circuit of the output tube. The current was much too high, due to a faulty speaker, causing a ground in the speaker circuit.

WM. C. MAYERS

CLARION 100

A SET of this model had been to two or three different Service Men and each had said the trouble was in a different place and one had even replaced a couple of tubes which were O.K.! The trouble was soon found to be the composite detector-oscillator tube which in this model is a 24, and is very critical. The tube in this position checked O.K. but the circuit refused to oscillate. After this tube was replaced with a carefully-selected one and the set completely trimmed (one of the other men had managed to get the circuits entirely out of alignment), the owner was tickled pink, and has brought more work to us.

LYRIC S-8

THE complaint on this set was speaker rattle and extreme distortion. The analyzer readings showed no grid bias on the 47s. The trouble was traced to a .5-meg. resistor which had opened, as shown in Fig. 6B.

LYRIC 8 TUBE (OLD MODEL)

THIS set was one of the old Lyrics which had a type 250 power tube and no model number (that the writer could find). Some other man had had it and, in attempting to replace a defective volume control, had completely "balled up" the connections, as well as using a control which was of the "all or none" type. It was found impossible to order a control for this set, since apparently it had no number, and to make matters worse the hook-up was not available. After a good deal of experimenting, the hook-up given in Fig. 6C was evolved for use with an Electrotype RI-201, 15,000 ohm-unit, which is the replacement for several models of the Lyric. The operation of the set is now very good and the control of volume is perfect.

GLORITONE 99-B

WHEN this set was installed in the cabinet, a loud whine would develop on high volume, the sound building itself up until the station program was drowned out. This trouble had not occurred while the set was on the bench, and it was determined that a noisy tube was not causing it. Upon investigation

SHORT-WAVE SET BUILDERS NEED THIS BOOK

Every experimenter who has attempted to build a short wave set knows by experience the difference between a good and a poor receiver is usually found in the short wave coils. Often you have to hunt through magazines, books, etc. to find the information you require. The present book has been gotten up to obviate these difficulties.

In this book you find every possible bit of information on coil winding. Only the most modern "dope" has been published. Illustrations follow, giving not only full instructions on how to wind coils but dimensions, size of wire, curves, how to plot them, by means of which any coil for any particular short wave set can be figured in advance, as to number of turns, size of wire, spacing, etc. There has never been such data published in such easy-to-read form as this.

25c Send your remittance of 25c in cash or unused U.S. Postage stamps for your copy of the SHORT WAVE COIL BOOK. Sent to you prepaid. RADIO PUBLICATIONS, 101C Hudson St., New York, N. Y.

BACK ISSUES of RADIO-CRAFT

which you might need to complete your files, can still be had at the price of 25c per copy. Send us your requirements, together with your remittance in check or money order.

RADIO-CRAFT

89 Hudson St., New York, N. Y.

Please Say That You Saw It in RADIO-CRAFT

it was found that if the oscillator condenser was shorted or the rotor plates rigidly held in the hand, the noise stopped.

The gang condenser is rigidly bolted to the chassis and the chassis bolted without any padding in the cabinet. After floating the chassis on blocks of rubber cut from an old inner tube, the trouble entirely disappeared. (The writer has read of similar cases where the speaker vibrated the oscillator plates, causing a type of modulation of the oscillator signal, which of course appeared again at the speaker, but this has been the first encountered in actual practice.)

ROBERT COE HANNUM.

MAJESTIC 15

NO PLATE voltage on R.F. and I.F. tubes was traced to a shorted I.F. transformer. C. BRITTON.

"WIDE-RANGE, VARIABLE OUTPUT P. A. AMPLIFIER"

The following interesting data supplements the above-titled article in RADIO-CRAFT (December 1934, page 347)

The Four Position Mixer

It will be noted by reference to Fig. 1 that provision is made for the amplification of any type of signal coming over a 500 or 200 ohm transmission line; from a 5,000, 500, 200, or 50 ohm phono pickup; from a radio tuner or other high-impedance device as, for example, a crystal pickup or microphone; or from a 200 ohm double-button carbon microphone.

The constructor or purchaser should bear in mind that the input transformers employed in this standard model may be varied to meet his own particular requirements. Thus 4 microphone transformers may be substituted for controlling from one to four microphones. Of course, any one, two, or three input coupling units may be omitted depending upon immediate requirements, while additional input transformers may easily be added whenever the occasion arises for the amplification of some new input device.

Figure 1 shows the standard input circuit with four 50 ohm "T" pad (constant-impedance) attenuators, each one controlling its individual input circuit without disturbing the impedance relationship of the entire circuit or affecting the degree of attenuation of the other circuits.

A double-pole, double-throw switch (shown at the left of each of circuit attenuator, A, in Fig. 1) simultaneously connects or disconnects each input circuit and operates a pilot light which illuminates the attenuator dial of the circuit involved. It will be noted that a dummy load resistor (50 ohms) is placed across each attenuator whenever its associated transformer secondary is disconnected. This precaution insures a constant-impedance relationship of the entire mixing system without affecting the master gain control, B, which is a 200 ohm "T" pad and used to attenuate the 200 ohm primary of 200 ohm-to-grid transformer.

Two additional D.P.D.T. microphone current switches and an 0-25 ma. Weston meter complete the input control panel system. A 500 ohm microphone current control in series with a 20,000 ohm 20 watt resistor furnishes 10 to 25 ma. of pure (highly-filtered) direct current for the microphone. Note the 50 mf. electrolytic condenser (connected to the microphone current control) which completely and effectively removes all trace of residual hum from the microphone current supply. Needless to say, this input control system will adequately meet any form or type of public address installation or application without any sacrifice of operating efficiency or overall fidelity.

Triple Range Class A and B Output

Every public address engineer knows that there is nothing superior to class B amplification for the most economical production of high-power outputs. It is also equally well known among the aforementioned fraternity that nothing is equal to class A amplification for true high-quality audio output.

Many inexperienced individuals have been led to believe that class AB (A prime) amplifica-

"Multi-Tap"

POWER TRANSFORMERS!

(Patents Allowed)

STOCK OF ONLY FIVE (5) POWER TRANSFORMERS provides immediate renewal of original performance in case of trouble in the transformer—the heart of the radio—in any of over 95% of all radios—whether "orphaned" or current models.

Exact duplicates ELECTRICALLY The wide range of adaptability of only five models Power Transformers is made possible through various taps in these units which may be used singly or in combinations. The required current values can be delivered to each of the several leads in the set with any combination of tubes, as accurately as by the original power units. Easily installed.

Universally adaptable PHYSICALLY The extremely wide range of adaptability physically is made possible with the scientifically staggered mounting slots in the several sides of the frame. This is very essential in many installations to avoid redrilling and defacing the mounting panel.

IMPORTANT. Fully approved for radios having Underwriters Lab. approval. Protects set owner's fire insurance policy. No extra unusual leads to become shorted.

The above are typical of the GENERAL group of power—audio—input—flament—line—mike—amateur—class "B" transformers, slakes, auto-radio "B" units and vibrators. The most comprehensive line of replacement units from one manufacturing source of supply—service engineers' every need.

All GENERAL transformer cores are of a low loss, high permeability silicon steel, all coils are high vacuum impregnated, removing all moisture and assuring permanent dependable performance under any climatic conditions. GENERAL QUALITY assures set-owner satisfaction and dealer profit.



Free for the Asking! "Multi-Tap" Guide, listing 2114 models of radios which you can immediately service with one of only five (5) "Multi-Tap" Power Transformers.

General Transformer Corporation
504 S. Throop St., Chicago, Ill.

MAIL THIS TODAY

General Transformer Corporation,
504 S. Throop St., Chicago, Ill.

Send me without charge a copy of "Multi-Tap" Guide with name of nearest distributor.

Name _____

Address _____

City _____ State _____

A Mighty Mite!! The FULTONE "DUETTE" ALL-ELECTRIC—one tube

TWO-IN-ONE—4"x4"x5 1/2"—2 1/2 POUNDS COMPLETE

A powerful handful of radio that will surprise you with its volume and reception ability. European S.W. Broadcast stations are easily picked up with excellent head-phone volume! Uses the new two-in-one type 12A7 Tube! High gain pentode detector and power rectifier. A real, powerful two tube receiver! This set is certainly not to be small enough to fit in the palm of the hand! Very, very inexpensive! Yet—the Fultone "Duette" has features found only in much higher priced receivers—

Smooth acting friction drive vernier coil—Quiet regeneration control—Front panel adjustment for sensitivity—Built-in power supply providing all voltages needed. Set plugs into any 105 to 130 volt AC or DC house line—Line noise and tunable him filter—Power switch—Attractive durable metal chassis and cabinet—Complete coverage from 15 to 625 meters (It gets everything!) Easy construction kit includes all necessary parts, drilled chassis and cabinet, 15 to 200 meter coil and simple instructions. \$4.45

Sylvania 12A7 tube \$.95
200 to 625 meter broadcast band coil . . . \$ 1.25

SPECIAL COMBINATION OFFER \$6.25
Complete Kit, tube, and B.C. coils

FULTONE "DUETTE" BATTERY MODEL \$3.75
Uses the new type 19 tube—two separate tubes in one hull! Detector and one stage audio amplifier. Economical operation on two dry cells and one or two B batteries. Complete construction kit, as above.

COMBINATION OFFER \$5.50
Complete Kit, tube, and Broadcast Band coils

HARRISON RADIO CO., 142 LIBERTY ST., Dept. R3, NEW YORK, N. Y.

tion combines into one system all of the desirable features of class A and class B amplification. Such is not the case. Aside from the fact that AB circuits require critical adjustments, and the operation of tubes at sometimes detrimental voltages for which they are not designed they are at their best halfbred versions of the A and B circuits not only in respect to power output but in quality of output and economy of operation as well.

When a careful survey is made of all these symptoms you cannot escape the fact that class B amplification is unequaled for high-power output and economy of operation, while class A reigns supreme for quality. It is because of these reasons that this amplifier is equipped with an output power selection switch for true high-fidelity class A 5 watt output (from two type 45 tubes); and 25 or 50 watt wide-range class B output.

This triple output feature is of inestimable value to the practical P.A. man who knows that if he builds or purchases this amplifier, he has in one compact unit all the power, quality, gain, and universality of operation and amplification that he will ever require in his work whether it be electioneering, audible advertising from an aeroplane, automobile or boat, studio recording, telephone line amplification, low-level program recording, or a thousand and one other applications for which this system is admirably suited.

Pre-Amplifier Circuit

By referring again to Fig. 1 you will note that the first 6A6 is used as a high-gain, two stage, resistance-coupled pre-amplifier, the first triode section of the tube being resistance-capacitively coupled to the second. The overall gain of this two stage unit exceeds 720. A laboratory check of the output wave form of the first two stages

CHEKATUBE '15⁹⁵

P.O.B. Factory



Tests all present radio tubes—Ample provision for new tubes—List 5 200 tubes with instrument—99 popular uses in hand. No. of plates—Diode and 2nd plate tests—Neon short test up to 2 megohms. P.O.D.R. 2—G.O.D.R. meter scale—D-Arrival movement—Line voltage on meter—One button for tube value—Portable sliding front leatherette case as shown—Cover removable for counter use—Size 10x11x6 inches—Weight 10 lbs.—Simple to operate—Accurate—Highest quality equals \$40 testers—Order limited—Regular Price \$24—Money back guarantee—You take no chance—Order today—As shown 60 cycle 120 volt \$15.95 each or \$2 with order balance C.O.D.—ORDER NOW—

Established in 1922

J-M-P Mfg. Co., Inc.
3038 N. 34th St., Milwaukee, Wis.

Please Say That You Saw It in RADIO-CRAFT

WELLWORTH TRADING COMPANY CHICAGO

560 W. WASHINGTON BLVD.

Electrical PORTABLE SPRAYER Outfit

\$27⁵⁰
COMPLETE

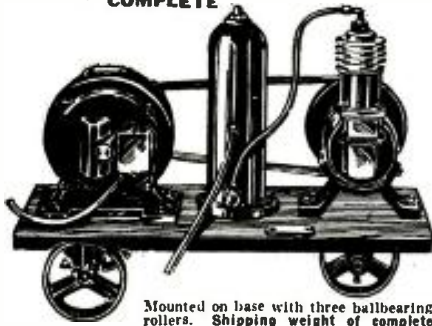

Mounted on base with three ballbearing rollers. Shipping weight of complete outfit, 55 lbs.



Internal Mix Spray Gun Supplied with the Portable Electric Sprayer.

This is the outfit for all-around spraying work wherever current is available. You can spray paint, varnish, ducos, enamel, lacquer, insecticides, etc., with it. Simply insert plug into electric socket and this marvelous machine is ready. Outfit equipped complete with Internal Mix Spray Gun, with quart aluminum cup, round or fan spray, 1/4 H.P. heavy duty motor, 110-volt, 60-cycle AC, air filter, Kellogg Air-Cooled Compressor, 1 3/4 x 1 3/4, 15 feet of hose, cord and plug.

Price of Complete Outfit with Gun, \$27.50

Internal Mix Spray Gun alone.....	\$ 7.50
Filter Tank alone.....	4.25
Kellogg Air-cooled compressor alone.....	7.50
Price of complete outfit without motor.....	20.00

WELLWORTH TRADING CO.
560 West Washington Blvd., Chicago, Ill.

RC-335

I enclose \$..... for which please send me the following:

Name Address.....
City State.....

WESTINGHOUSE POWER GENERATOR

Manufactured for U. S. Signal Corps

SPECIFICATIONS:

HOUSING—Aluminum (Diameter 6 1/4 in. Length—3 1/2 in.)
SHAFT—2 3/16 in. (driving end) Diameter 9/16 in. (the end is threaded for a distance of 1/4 in.)
BASE—Cast iron (Length—7 1/4 in. Height 1 9/16 in. Width 1 3/4 in.)
OUTPUT—200 Watt 110 volts AC (speed 4500 R.P.M.)
STATORS—Two pairs (two North and two South)
ROTOR—12 tooth inductor.
Built-in commutator.
Rotor turns in ballbearings.



ups and installing explanations. We also include a set of four replacement carbon brushes.

FREE With each Generator we supply a set of diagram-blue prints and instructions showing twenty-five different uses, technical information, electrical hook-

There Are Over 25 Applications
Some of which are:

A.C. Dynamo lighting from eight to ten 20 Watt 110 Volt lamps. Short Wave Transmitter supplying 110 Volts AC for operating "Ham" transmitter. Operating 110 V. AC 60 Cycle Radio Receiver in DC districts. Public Address Systems. Camp Lighting, etc., etc. Furthermore the following uses are explained:

How to obtain electrical power: from a Windmill, Water power, Automobile, Motorcycle, Bicycle, Footpedals or Handcrank; how to operate AC Radio sets from 32 V. DC farm light systems, etc., etc.

Generator, as described, including four replacement carbon brushes and instructions..... **\$7⁹⁰**
Shipping weight 18 lbs. (Replacement carbon brushes bought separate \$1.50 per set of four. Set of instructions bought separate \$1.00.)

Heavy Duty Metal Cutting Lathe



LENGTH: 20 in.
WIDTH OF BASE: 4 in.
HEIGHT OVERALL: 9 in.
SPEED: Two-step pulley.
FINISH: Baked-on GRAY ENAMEL.
COMPLETE with Compound Slide rest having Swivel base and tool holder. Large oversized bronze bearings. Accurately planed bed, machined face plate. Hollow spindle, 5 in. swing. Standard Morse tapers; 13 in. between centers. Shipping **\$6⁹⁵** weight: 26 lbs. \$3.30 extra for chuck (4 jawed, 3 in. diam.) less chuck

ORDER FROM THIS PAGE

SINCE WE DO NOT PUBLISH ANY CATALOG! Remit by check or money order for full amount of each item—shipped by express collect, if no money for P.P. enclosed. No C.O.D. Money refunded if not satisfied.

All Merchandise Offered in This Ad is Absolutely New and Unused

Are You Interested In FICTION?

In this issue you will find announcements of importance telling about the popular fiction pulp magazines which are now published... turn to them and get complete details about

WONDER STORIES
PIRATE STORIES
HIGH-SEAS ADVENTURES

SEXOLOGY

The Magazine of Sex Science. Foremost educational sex magazine. Sex secrets in plain English. Instructive and enlightening—not a risqué book—contains no offensive matter. Know thyself! All articles written by doctors. Each issue contains 25 important sex articles; 68 pages, numerous illustrations. Our doctors answer your sex questions FREE. Send 15c for sample or \$1.00 for 3 months subscription. SEXOLOGY, 85R Hudson Street, New York City.

Design Curves for Pads!

Set of curves and instructions for designing pads of any value from 0 to 40 db and to match any impedance. Very helpful in public address system and radio broadcasting installation and maintenance. Will save many hours of labor. Complete set mailed post-paid for \$1.50. Address:

R. E. WILLEY
4629 York Avenue So., Minneapolis, Minnesota

WALCO'S SOUND RECORDING INSTRUMENTS

Service-men—Dealers—Technicians
Write for our latest catalog on Home Recording Apparatus.
FREE No obligations. Consult us about P. A. and Home Recording Installations.
ELECTRICAL LABORATORIES CO., Inc.
141 East 25th St. New York, N. Y.

showed no distortion whatsoever (as viewed on the screen of a cathode-ray oscillograph).

Because of the high gain characteristic of the 6A6 when used in this circuit arrangement, it is imperative that the following two special precautions be taken.

(1) A high-low gain switch must be incorporated to cut the gain of the first tube down to 26.8 (instead of 720) when high-level input devices are employed and the extra gain is not required. This is accomplished by a D.P. D.T. toggle switch which feeds the secondary of the input transformer either into the first, or into the second triode section of the pre-amplifier tube. When the signal is being fed into the second section, the first grid is shunted to the 100,000 decoupling resistor which removes all audio signal from the grid but maintains its correct bias.

(2) It is imperative that no hum voltage affect the pre-amplifier grids, and so, decoupling resistors are placed in series with the grid resistors which are bypassed through 25 mf. electrolytic condensers. These condensers not only provide low-impedance paths for the signal voltage, but also maintain a practically constant bias, regardless of the current surges flowing through the cathode resistors. This "fixed bias" prevents degeneration of the audio signals. A study of the diagram will show that this decoupling arrangement has been used throughout the first four resistance-coupled stages.

Amplifier and Phase Inverter

Another interesting application is shown in the circuit arrangement of the second 6A6 tubes. Here, the circuit operates as a combined amplifier and phase inverter. Phase inversion, it will be remembered, is the only transformerless method for feeding a true resistance-coupled push-pull stage from a single-tube amplifier and is accomplished by connecting the plate of the first triode section (of the second 6A6) through a .1-mf. condenser and 0.5-meg. resistor into the grid of the second triode section. A grid resistor of 50,000 ohms and a decoupling resistor of 10,000 ohms complete the circuit. These con-

stants are chosen so that a portion of the A.F. voltage developed across the plate load of the first triode section is impressed upon the grid of the second triode section exactly 180 degrees out of phase with the voltage impressed on the grid of the first section. Therefore, the grids of the succeeding stage (two 45s) may be resistance-coupled to both plates of the combined amplifier and phase-inverter tube.

True Class A Drivers

Two type 45 tubes were chosen as class A drivers of this amplifier for the following reasons:

(1) 45s in class A push-pull are noted for their high-quality output.

(2) They are capable of generating more than sufficient power to operate the class B output stage (a power output of 2 1/2 watts is required from the drivers for full 50 watt output). They can deliver 5 watts before the slightest trace of distortion is introduced.

(3) The recommended plate load of the 45s as used in this amplifier are identical with the recommended plate load of the output channels. This permits the use of the same output channel No. 1 transformer for use with 5 or 25 watt output; and eliminates the necessity of changing any speaker connections when switching from low- to medium-power output.

Both grids of the 45s are maintained 56 volts negative with respect to their filaments through a voltage drop in the 875 ohm biasing resistor. Two 10 mf. electrolytic condensers maintain a steady potential across the input circuit of both tubes so that no hum is introduced into the output waveform. The two 1-mf. condensers bypass any R.F. currents that may be present in the heater circuit.

Distinguishing features of these circuit arrangements are: (1) No power is required by the grids of the type 45 tubes. (2) Five watts of undistorted power is obtained with the two 45s in a true class A push-pull circuit—which is the nearest approach to distortionless amplification known. The output of these driver tubes is brought to two poles of the "5 to 25 watt"

Please Say That You Saw It in RADIO-CRAFT

Many Auto-Radios Installed Last Summer Now Need Servicing!

Auto-radios installed during the past six months usually need some minor adjustment—new tubes, new suppressors or other parts. Perhaps the job will even be more difficult—then you'll find how needy the Auto-Radio Service Manual is to repair the job quickly.

\$2.50
LIST

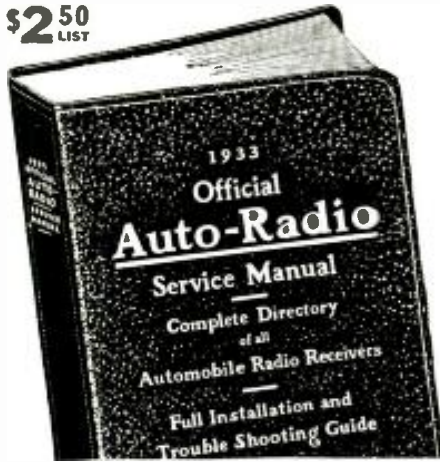

To everyone who now purchases the OFFICIAL AUTO-RADIO SERVICE MANUAL this big 48-page Supplement is issued FREE. Practically all of the latest sets, together with servicing information will be found in these new pages. The new Supplement does not increase the cost of the book to you, but gives you an Auto-Radio Service Manual that is right up-to-the-minute with service notes.

Good Money in Servicing Auto-Radios

If you are overlooking servicing auto radios, you're missing a great deal of business. The auto-radio business had its greatest boom last summer when thousands of sets were sold. By now many of these same sets require servicing and with hundreds of them right in your own community, you can build up a good auto-radio servicing business. In a short time you can easily add 25% profit or more to your regular servicing business.

List of sets covered in the Manual

- | | |
|-------------------------------|----------------------------|
| Acme Radio Mfg. Co. | P. R. Mallory & Co. |
| Allied Radio Corp. | Melhorn Radio Mfg. Co. |
| Atwater Kent Mfg. Co. | Montgomery Ward & Co. |
| Audiola Radio Co. | National Co., Inc. |
| Autocrat Radio Company | Nobilit-Sparks Intl. Inc. |
| Automatic Radio Mfg. Co. | Philco Radio & Tel. Corp. |
| Carter Genemotor Corp. | Pierce-Alfo, Inc. |
| Century Radio Prods. Co. | Premier Electric Co. |
| Chevrolet Motor Company | Radio Chassis, Inc. |
| Consolidated Industries, Ltd. | RCA-Victor Co., Inc. |
| Crosley Radio Corp. | Sentinel Radio Corp. |
| Delco Appliance Corp. | Sharks-Withington Corp. |
| Petrola Radio Corp. | Stewart Radio & Tel. Corp. |
| Emerson Electric Mfg. Co. | Stewart-Warner Corp. |
| Fada Radio & Elec. Corp. | Mfr. Co. |
| Federated Purchaser, Inc. | Transformer Corp. of Am. |
| Ford-Majestic | United Amer. Bosch Corp. |
| Franklin Radio Corp. | United Motors Service |
| Gairin Mfg. Corp. | U. S. Radio & Tel. Corp. |
| General Electric Co. | Utah Radio Prods. Co. |
| General Motors Corp. | Wells-Gardner Company |
| A. H. Grebe & Co. | Wholesale Radio Serv. Co. |
| Grigsby-Grunow Co. | Rudolph Wurlitzer Mfg. Co. |
| Chas. Hoodwin Company | |
| International Radio Corp. | Zenith Radio Corp. |

Over 200 Pages

Over 500 Illustrations

9 x 12 Inches

Flexible, Loose-Leaf Cover

MAIL THIS COUPON TODAY!

GERNSBACK PUBLICATIONS, INC. RC-3-35
99 Hudson Street, New York, N. Y.

Enclosed you will find my remittance of \$2.50 for which please send me One Copy of the OFFICIAL AUTO-RADIO SERVICE MANUAL with FREE 48-page Supplement. Send remittance in check or money order. Register letter if it contains cash or currency. WE PAY POSTAGE.

Name

Address

City State

switch which connects them either to the interstage class B transformer for driving power, or to the output transformer of channel No. 1 for high-grade audio work.

The interstage transformer (T1) is the link between the class A driver and the power output stage. The step-down ratio of the transformer is designed to prevent distortion in the class B stage.

As the quality of the power output is to a large extent dependent upon the design of this transformer, particular care was taken in the construction to maintain a low leakage reactance so as to avoid loss of high frequencies. In view of the fact that a power of only 2½ watts is required to drive both channels for full 50 watts output the output stage attains maximum output long before the driver stage is fully loaded. This design feature thoroughly precludes the slightest trace of distortion from being generated in the driver stage and passing on into the output.

Two 50,000 ohm resistors are shunted across the secondary of the push-push transformer. They are used as a precaution against super-regenerative distortion due to transient dynatron characteristics. The high mu characteristics of the 6A6 sometimes causes its circuit to oscillate on peaks. This condition is entirely eliminated by the use of a speaker-correction network and grid-to-ground shunt resistors which also tend to stabilize the reflected load across the driver tubes.

Solving the Hum Problem

Sound engineers may wonder what trick has been used to allow the inclusion of five different input transformers within the same chassis, that houses this 5 stage, high-gain and high-level amplifier, without experiencing any power transformer or other extraneous hum pickup. They might reason that while it may be possible to use a 3 or 4 stage A.C. operated amplifier to amplify the output of a carbon microphone, the output level of a velocity, dynamic or crystal microphone is so far "down" that some trace of hum would be present in the output circuit at full gain settings.

The truth is that no trick is employed. Common sense tells us that if no hum is introduced into the input circuit, there will be no trace in the output whether the gain of the amplifier system be 50, 90 or 118 db.

The four factors which determine the presence, or lack, of hum in any type of amplifier are listed as follows, in the order of their relative importance:

(1) *Selection of the proper tubes:* Where high gain takes place, the tube must be of such a nature, that, when being operated from A.C. voltage, the alternating current passing through the heaters will not induce voltages on any portion of the grid or within its supporting structure. (The internal construction of the 6A6 makes it admirably suited for high-gain work without danger of internal hum pickup).

(2) *Complete shielding:* The usual causes of electromagnetic and electrostatic hum pickup within the input transformers are effectively eliminated by using quadruple shielding around these units. The first and third shields being copper, while the second and fourth are made of a high-permeability steel. By using a closed, E-type core in designing the input transformers, a considerable portion of the strong magnetic fields is balanced out.

(3) *Isolation of the power transformer:* Failure to isolate the power transformer is a common cause for hum in most amplifiers. Under no conditions should this unit be placed any closer than 15 ins. from the nearest input transformer. At least one copper, and one high-permeability-steel shield should be used around this device.

(4) *Careful installation:* A common mistaken belief held by most P.A. men, is that a hum-free amplifier (A.C. or battery operated types) will operate hum-free anywhere and under any condition of installation. Experience has shown that while an unshielded, battery-operated amplifier will operate quietly in a vacant lot or at any other location isolated from stray fields, it will not provide hum-free operation when the amplifier or its input device (microphone, pickup, etc.) is placed within the electromagnetic or electrostatic fields of an A.C. line. It should not be forgotten, that all high-gain amplifiers must be used with a completely shielded (or grounded-case) input source. If this precaution is overlooked, all of the careful hum-eliminating design features will be lost.

Please Say That You Saw It in RADIO-CRAFT

FREE LEADING CATALOG For 1935!

Send for the most complete and truly timely book in Radio—over 100 amazing pages—devoted exclusively to Radio—a great Profit Guide—packed with real Radio "Scoops" at consistently lower prices.

- NEW. Dual Wave, All-Wave, Short Wave, and Broadcast receivers.
- NEW. More than 15 Great Build-Your-Own Radio kits.
- NEW. An amazing selection of new Test Equipment for Servicing at low prices. If you build, service, or sell Radio, you need the ALLIED Catalog.



SEND FOR THIS GREAT NEW BOOK!

- NEW. A great section devoted to Amateur Radio. New S.W. gear, receivers, transmitters, antennas, tubes, etc.
- NEW. The greatest P.A. array in Radio—1 to 10 watts—new, different, superior. And, of course, Radio's most complete stock of perfect Standard Quality replacement and Set-building parts. Let us quote you for kits covering any circuit appearing in any magazine or handbook, SEND FOR YOUR COPY TODAY.

Allied Radio

633 W. Jackson Blvd., Chicago Dept. D
 Please send me your FREE 1935 Catalog.
 Please Quote for Kit described in

Name
Address
City State

ALL-WAVE OSCILLATOR KITS!

37AC-K Foundation Kit
For constructing Model 37 AC Oscillator, having 3 switch bands from 132 kc. to 3.8 megacycles. Consists of:

- 1 Special tuning condenser.
 - 1 3½" Etched frequency dial.
 - 1 Bronze double-pointer escutcheon plate.
 - 3 Accurate coils for I.P., broadcast and S.W. bands.
- Shipping Wt., 1 lb. ONLY, \$3.95

37AC-K COMPLETE KIT
The following parts, besides those in the above foundation kit:

- 1 Black cracked steel cabinet with handle.
- 1 Engraved and drilled bakelite panel.
- 1 Special bakelite bracket, drilled and tapped.
- 1 Nickel plated steel bracket for condenser and tube mounting.

1 Two circuit, 3 point switch.
1 350 ohm resistance line cord.
Shipping Wt., 3 lbs. ONLY, \$6.95

37AC Wired and completely lined up, supplied with tube. Shipping Wt., 4 lbs. For only.....\$9.50

Prompt Deliveries Guaranteed

DELTA RADIO CO.
135 Liberty St.,
NEW YORK, N. Y.

BEGIN MAKING MONEY

in Public Address

with COLUMBIA

SOUND AMPLIFIERS

Write for FREE Catalogue

COLUMBIA SOUND CO., INC.
135 LIBERTY ST., NEW YORK, N. Y.

ALL-WAVE RECEIVER— 15 to 2,700 Meters

HERE is a TRULY ALL-WAVE receiver; all-wave in the strictest sense of the word. It has the enormous range of from 15 way up to 2700 meters. Just consider what this means, 15 meters approaches the ultra short wavelengths; from there the range of the set continues on up through the amateur bands, television bands, police and airplane bands right into the regular broadcast band and from there further up into the upper channel of foreign speech and music broadcast bands; this, mind you, all with a 4-tube miniature receiver. That is why we say it is an "all-waver" in the strictest sense of the word.

Not only that but the receiver will work from any source of electricity whatever, be it an electric supply main, storage batteries, 32 volt farm lighting plants, or what have you. The special adaptors listed below will adapt this receiver to any and all of these electrical sources. The receiver uses only the very latest type of tubes such as 6F7.

A series of 7 coils are used to cover the tremendous reception range.

Dynamic speaker, built-in antenna and provision for phonograph pickup. The receiver consumes as little as 40 watts on 110 volts and 80 watts on 220 volts. The receiver is housed in a steel cabinet, burly-walnut finish. Measures 8 3/4" wide, 6" high, 3 3/4" deep. Ship. wt., 12 lbs.

- No. 321-V Universal All-Wave Receiver Including Tubes But Less Coils, (110 volt A.C.-D.C. Operation. List Price \$21.50. **YOUR PRICE \$12.60**
- No. 322 Set of 4 Plug-in Coils (15 to 200 meters) List Price \$4.00. **YOUR PRICE \$2.30**
- No. 323 Set of 3 Plug-in Coils (200 to 2700 Meters) List Price \$3.00. **YOUR PRICE \$1.76**
- No. 324 All Electric Auto Adapter With Suppressors, for use in automobiles or boats. List Price \$12.50. **YOUR PRICE \$7.30**
- 220 volt AC-DC adapter—**YOUR PRICE \$0.88**
- 32 volt farm light adapter—**YOUR PRICE \$5.95**



321-V

**Works from ANY
ELECTRIC SOURCE
Including Batteries**

**FREE
Radio
and Short Wave
Treatise**

108 Pages
1500 Illus.

Enclose five cents (coin) for postage. Treatise sent by return mail. Print name and address clearly on request.

Completely revised and enlarged, this new 1935 edition contains 108 solid pages of useful radio information, diagrams, illustrations, radio kinks and real live radio merchandise. **PARTIAL LIST OF CONTENTS:** Fundamental Principles of Radio for the Beginner, Chapter 2—Fundamental Circuits and Uses of New Tubes, Revamping Six-Volt Battery Sets for Two-Volt Tubes, Public Address Systems, How to Build Short-Wave Transmitters and Receivers, Up-to-Date Tube Chart and Socket Connections, etc., etc.



WRITE Today

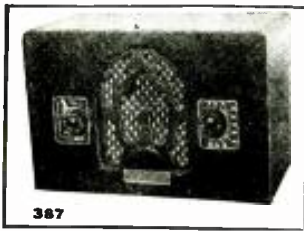

387

**Now \$10.90
Only**

**NOTHING ELSE
TO BUY**

An AMAZING VALUE! 4-TUBE AC-DC RECEIVER 200 TO 550 METERS—BROADCAST

HERE is one case where price does not follow quality—for although the price is down, the quality is up. Uses 1-25Z5, 1-38, 1-36 and 1-39-44—and yet with these simple tubes brings in stations which for their distance and clarity will amaze the most skeptical broadcast listener. Has a built-in antenna and requires no ground. You can take it anywhere—any place where 110 volts either A.C. or D.C., 25 or 60 cycles, is available.

The set measures but 10" wide by 5 3/4" deep by 7 3/4" high. Shipping weight 16 lbs. List Price \$23.50. **Model 387, 4 Tube A.C. Broadcast Receiver, Complete with Tubes, List Price \$23.50. YOUR PRICE \$10.90**
Model 387 5-Tube AC-DC Broadcast Receiver. YOUR PRICE with Tubes. \$12.90

TERMS
Send money order, certified check or new U. S. stamps. C.O. D. shipments only if 20% remittance accompanies order. If sent via parcel post include charges; excess refunded.

Radio Trading Co., 97 Hudson St., New York City

BOOK REVIEW

MEASUREMENT IN RADIO, by F. H. Lumley. Published by The Ohio State University, 1934. Size, 6x9 ins., 318 pages, cloth bound. Price, \$3.00.

The title of this new volume is apt to suggest technical formulas and profound mathematical equations. In that sense it is misleading. There isn't a single equation in the book. It deals exclusively with the field of radio-listener response to broadcast programs and how the broadcast station can ascertain such response to its transmission. The subject is admirably covered, showing long and thoughtful study and preparation. There should be a demand for its clearly written information.

Contents include: General Methods in Measurement; Special Principles of Measurement; Analysis of Mail Response; Questionnaires, Report Forms, and Tests; Methods of Personal Contact; The Telephone in Measurement; Analyzing Sales Response; Special Methods of Measurement; Results of Surveys; Psychological Factors in Listening; Synopsis of Methods. A 55-page appendix supplements the text.

LES PARASITES EN T. S. F. ET LEUR ELIMINATION, by R. Singer. Published by Publications Cinematographiques, Paris, France. Size 5 1/2 x 8 1/2 ins., 79 pages, profusely illustrated, paper cover. Price, 12 francs.

Opening with a set of figures which tend to prove that atmospheric interference is responsible for only 18.4% of total disturbances affecting radio reception, the author then explains how electrical devices produce interference and shows how combinations of impedance and capacity can reduce it.

A list of French governmental regulations against parasitic noises is appended. The book is written entirely in French.

Index to Advertisers

A	Aerovox Corporation.....	568	Midwest Radio Corp.....	569
	Allied Radio Corporation.....	554, 575	Multiplex Radio Service.....	566
	American Technical Society.....	566	N	
B			National Radio Institute.....	515
	Belden Mfg. Company.....	553	National Union Radio Corp.....	563
	J. Mathewson Bell, Inc.....	568	O	
	Blan the Radio Man, Inc.....	565	Ohmite Mfg. Company.....	553
	Bruno Laboratories.....	561	Oak Mfg. Company.....	553
			Oxford Radio Corp.....	553
C			P	
	Capitol Radio Research Labs.....	561	Pioneer Sound Laboratories.....	568
	Central Radio Laboratories.....	556	R	
	Chicago Tool & Engineering Co.....	565	Radio Circular Company.....	561
	Coast-to-Coast Radio Corp.....	569	Radio City Products Company.....	571
	Columbia Sound Systems, Inc.....	575	Radio Electric Service Co.....	552
	Cornell-Dubilier Corp.....	553, 566	Radio Training Association.....	562
	Coyne Electrical School.....	513	Radolek Company.....	Inside front cover
	Crowe Name Plate & Mfg. Co.....	552, 553	RCA Institutes, Inc.....	561
D			Readrite Meter Works.....	557
	Delta Radio Company.....	575	Remington Rand, Inc.....	571
E			S	
	Ellen Radio Laboratories.....	565	S. O. S. Corporation.....	561
	Electrad, Inc.....	553, 555	Servicemen's Pub. Company.....	556
	Eric Can Company.....	533	Sars, Rodluck & Company.....	571
	Electrical Laboratories Co.....	574	Shure Brothers Company.....	565
F			Solar Mfg. Company.....	562
	Federated Purchaser, Inc.....	551	F. L. Sprayberry School.....	558
	Freel Radio Company.....	565	Supreme Instruments Corp.....	Back cover
G			T	
	General Transformer Corp.....	573	Thordarson Elec. Mfg. Co.....	553
H			Toledo Sound Equipment Labs.....	561
	Hammarlund Mfg. Company.....	553, 563	Triplett Elec. Instrument Co.....	565
	Harrison Radio Company.....	573	Try-Mo Radio Co., Inc.....	552
	Hygrade-Sylvania Corp.....	559	U	
I			Uncle Dave's Radio Shack.....	564
	Insuline Corporation of America.....	560	W	
J			Webster Company.....	567
	J-M-P Mfg. Company.....	573	Weston Elec. Instrument Corp.....	561
K			Wholesale Merchandisers, Inc.....	565
	Kato Engineering Company.....	565	Wholesale Radio Service Co., Inc.....	552
	Ken-Rad Corporation.....	561	R. E. Willey.....	571
L			Wright-DeCoster, Inc.....	558
	Leotone Radio Company.....	566		
Mc				
	McGraw-Hill Book Company.....	560		
M				
	Marlo Products Company.....	562		
	Mass. Radio School.....	565		
	Meissner Mfg. Company.....	553		

(While every precaution is taken to insure accuracy, we cannot guarantee against the possibility of an occasional change or omission in the preparation of this index.)

Please Say That You Saw It in RADIO-CRAFT

SERVICE MEN'S ESSENTIALS FOR ALL MEMBERS OF THE

ORSMA

WHAT ARE THE SERVICE MEN'S ESSENTIALS?

THE OFFICIAL RADIO SERVICE MEN'S ASSOCIATION has arranged to supply a number of "Service Men's essentials" for its members and associate members only. These essentials are priced at cost, plus a small additional fee, which is the only source of income that the Association has. No one obtains any profit or benefit, except the Association itself. Whatever profit accrues, is reinvested for the furtherance and enlargement of the Association.

By using the letterheads, billheads, etc., you present the business-like appearance to your customers. In addition, the Association has made arrangements with most of the prominent manufacturers to allow special discounts to members, providing ORSMA letterheads are used when ordering.



No. 14—50c each
(Plus 10c for Postage)



No. 5—50c each

No. 1 ORSMA LETTERHEADS

These letterheads, shown on the right, are furnished with your name, address and telephone number. Printed on excellent paper. They are sold in lots of 100 or multiples thereof, with a distinct saving for single orders of 1,000 or more. Per 100, 60c; per 1000, \$3.00.

No. 2 ORSMA ENVELOPES

These are furnished to match the letterheads, printed with your name and address and seal of the Association. They go hand in hand with the letterheads and are usually ordered in the same quantity. Per 100, 60c; per 1000, \$3.00.

No. 3 ORSMA SERVICE RECORD CARDS

These serve a double purpose; whenever you complete a job you fill out the report-bill and hand it to the customer; this is the "psychological moment" to collect. By the use of carbon paper a permanent record is kept. Furnished with name, address and telephone number. Per pad of 50, 60c; per 10 pads, each of 50, \$3.00.

No. 4 ORSMA INSPECTION LABELS

The label is to be filled in with the proper dates, and pasted inside the set or cabinet where the customer will see it. It is a continuous reminder to him that when service is needed, he can call you again. The advantage is apparent. Per 100, 60c; per 1000, \$3.00.

No. 5 ORSMA LAPEL BUTTON

At the suggestion of many members a handsome lapel button bearing the name and emblem of the Association has been designed. It signifies that you belong to the ORSMA; and in addition it gives your customers a better appreciation of the professional nature of your work. 50c each.

No. 6 ORSMA BUSINESS CARDS

These are furnished on a fine grade of paper in two colors with a blotter back. Thus they present an incentive to customers to keep them in a prominent place. They are printed with your name, address and telephone and bear the official seal of the Association. Per 100, 75c; per 1000, \$4.00.

Nos. 9 & 10 ORSMA EMBLEM CUTS

These cuts for printing, advertising, etc., are furnished in two styles and sizes. They may be used for newspaper or telephone-book advertisements or for printing of any kind. Large size, 1 1/4 x 1 1/4 in., \$1.35 each; small size, 3/4 x 3/4 in., \$1.20 each.

No. 11 ORSMA MEMBERSHIP SIGN

A set of three signs, printed on heavy cards, and having holes punched in order to hang in office or store. These are sold to members and associate members. Large enough to be quite prominent and the two tone effect makes them attractive. Set of three, 50c.

No. 12 ORSMA ADVERTISING DISPLAY SIGN

A two color sign printed in large letters with your name, address and telephone, with the seal of the Association. This sign is sold in quantities of 25 or more and is ideal for hanging in stores, offices, etc., for advertising purposes. Set of 25 cards, \$3.00.

No. 13 RADIO SERVICE MEN'S ASSORTMENT PACKAGE

This includes one gold filled label button, 100 letterheads, 100 envelopes, 50 service record cards, and 100 labels printed with your name and address as described above. The whole assortment costs only—\$3.00—a worth-while saving. Complete, \$3.00.

No. 14 ORSMA MEMBER CERTIFICATE

A handsome diploma-like certificate engraved on stiff vellum-bond. The certificate is personally signed by the President and Executive Secretary and the corporation stamp of the Association is impressed on a red seal attached to it. Your name, certificate number and date of registration are lettered by hand and the certificate is mailed in a cardboard tube to insure safe delivery. Each 50c, plus 10c for postage.



No. 1—60c per 100
\$3.00 per 1000

No. 3—60c per pad of 50
\$3.00 per ten pads, each of 50

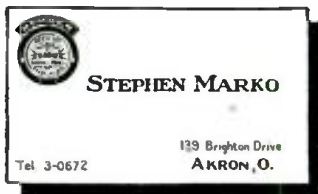

No. 6—75c per 100
\$4.00 per 1000



No. 4—60c per 100
\$3.00 per 1000

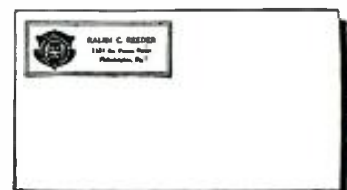

No. 2—60c per 100
\$3.00 per 1000

Application for Membership in ORSMA

Executive Secretary, ORSMA
99 Hudson Street, New York, N. Y.

Kindly send an application blank for

- Full Membership
 Associate Membership

Name

Street or Box

City..... State.....

RC-3-35

OFFICIAL RADIO SERVICE MEN'S ASSOCIATION

RC-3-35

99 Hudson Street, New York, N. Y.

Please send me the following RADIO SERVICE MEN'S ESSENTIALS which I have selected from this advertisement. My remittance for \$..... is enclosed. Send remittance in form of check or money order. Register letter if it contains cash, currency or unused U. S. Postage Stamps.

.....

.....

.....

Name ORSMA No.

Address City and State

As Good as it Looks

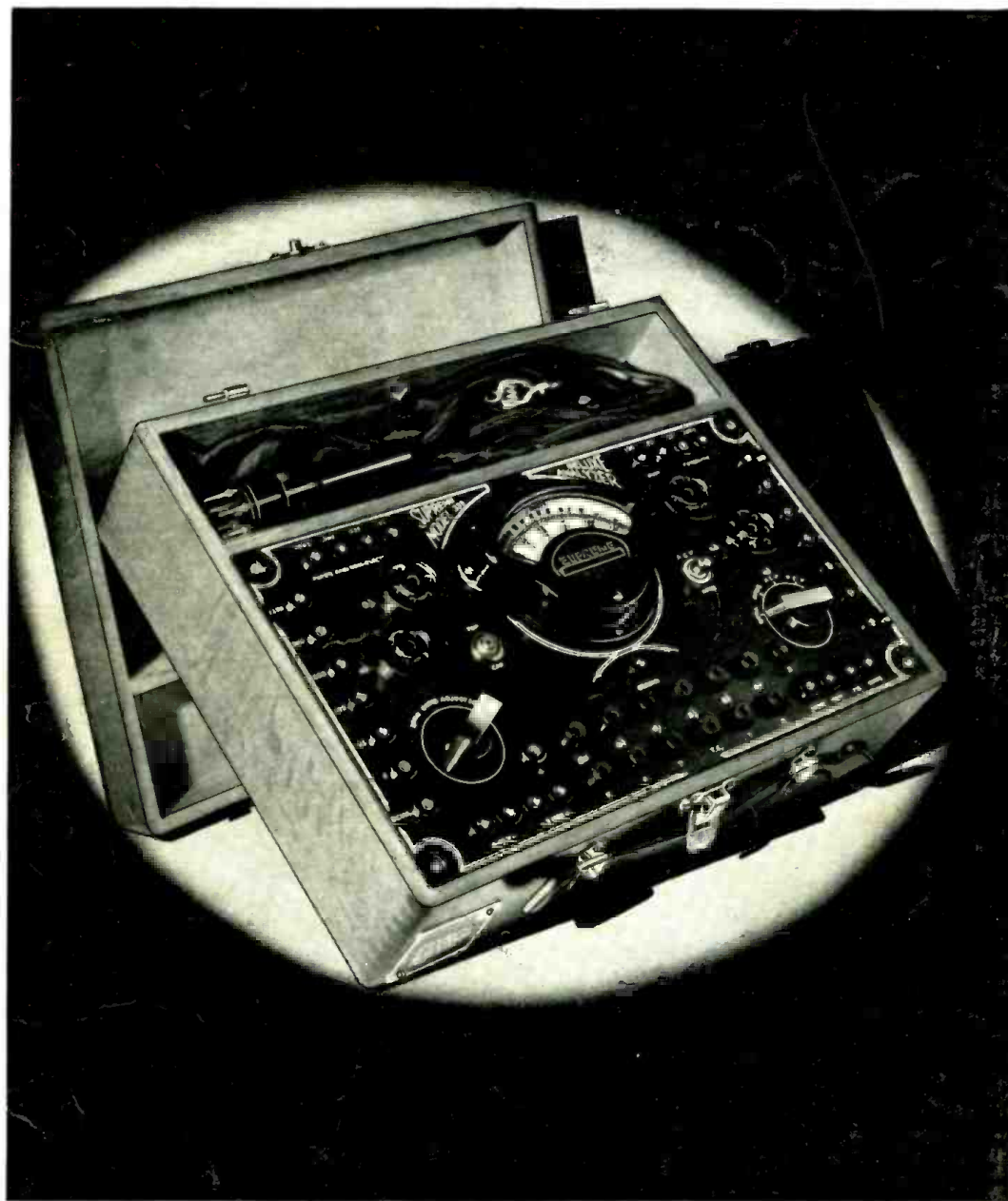

SUPREME 333 DELUXE ANALYZER AT YOUR JOBBER,
DEALER'S NET CASH WHOLESALE PRICE.....\$39.95

"The most complete and highest quality obtainable at anywhere near the price," writes a Wyandotte, Mich., radio serviceman. See it at your Jobber and convince yourself. Write for complete technical details and catalog of Supreme Instruments.

SUPREME INSTRUMENTS CORPORATION

517 Supreme Building

Greenwood, Miss.

Export Dept., Associated Exporters Co., 1457 Broadway, New York City